

### VZ589 DETAIL

2 PER UNIT

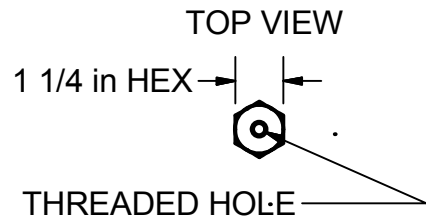

SIDE VIEW

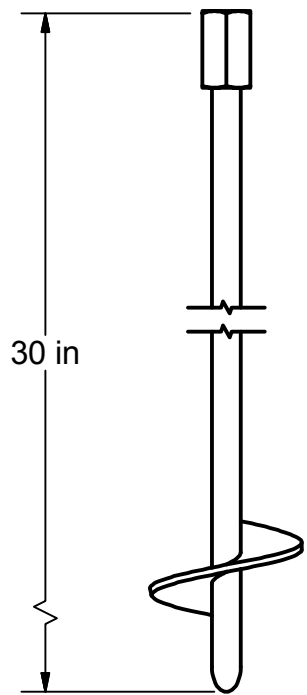

BOTTOM VIEW

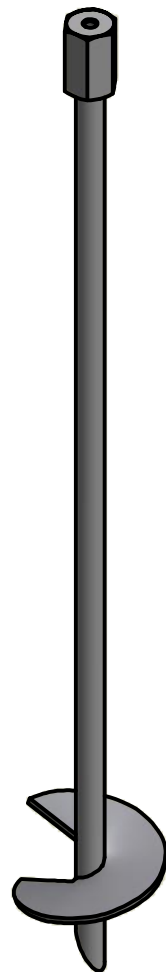
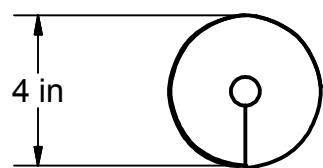

### VZ581 DETAIL

2 PER UNIT

TOP VIEW

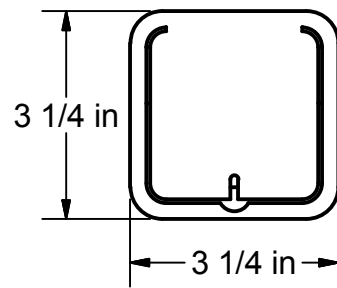

FRONT VIEW

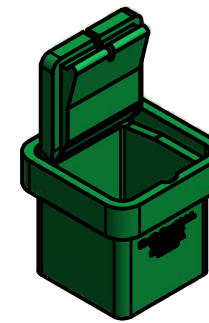
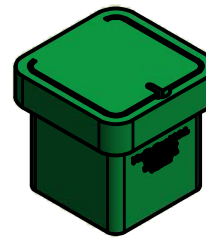
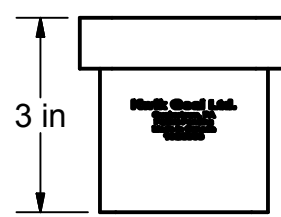

### VZ583 DETAIL

2 PER UNIT

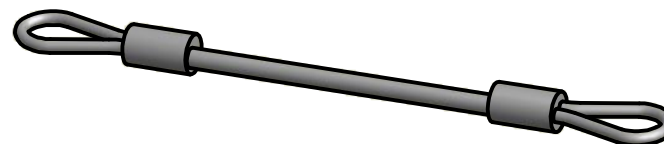
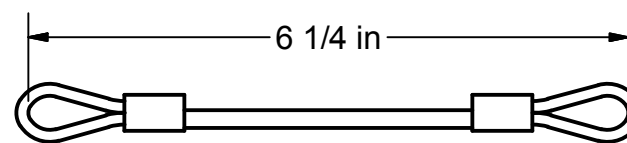

### VZ588 DETAIL

2 PER UNIT

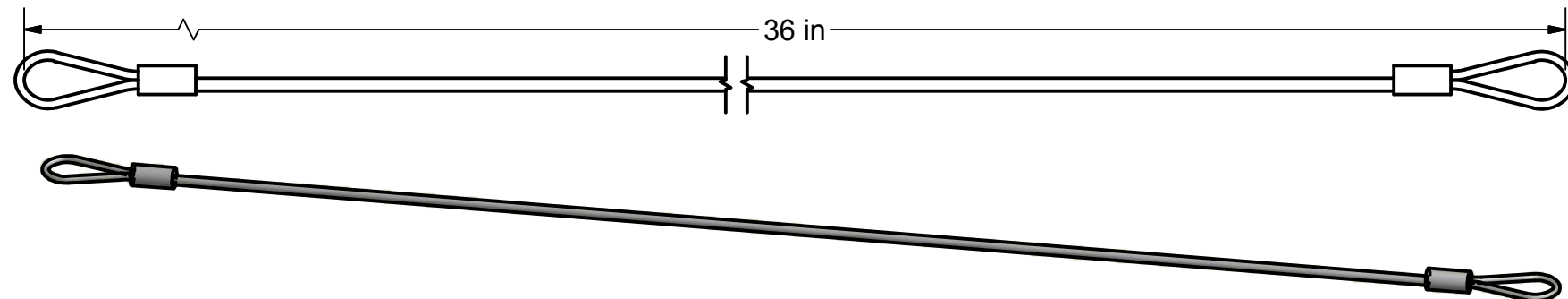

### Parts List

Part #	Qty	Description
TZ189	2	3/8 Flat Washer
TZ324	2	3/8-16 x 1 1/4 Soc Hd Cap Scr
TZ328	2	Washer Flat 3/8"-Polyurethane
VZ140	1	5/16 HEX DRIVER
VZ563	2	PADLOCK
VZ581	2	BOX ANCHOR
VZ583	2	CABLE LANYARD X 6 1/4"L
VZ588	2	CABLE LANYARD x 36"L
VZ589	2	AUGER ANCHOR
VZ624	2	CAPLUG CPT-2

### VZ583 DETAIL

2 PER UNIT

SIDE VIEW

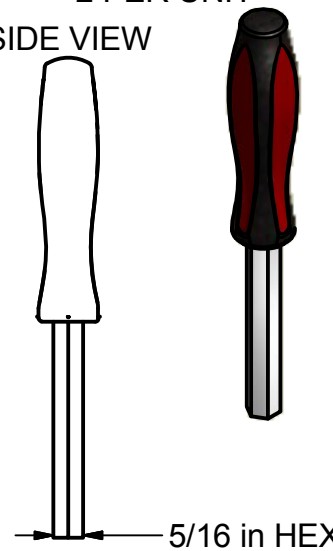

### VZ563 DETAIL

2 PER UNIT

SIDE VIEW

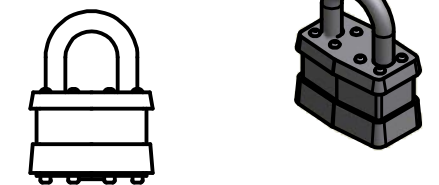

BOTTOM VIEW  
KEYED ALIKE



#### FEATURES:

- 1) RECOMMENDED FOR NATURAL GRASS FIELDS TO MINIMIZE DISRUPTION OF FIELD SURFACE.  
NO CONCRETE OR EXCAVATION REQUIRED
- 2) INCLUDED:  
  - ANCHOR BOX - GREEN URETHANE WITH A SOFT TOP
  - AUGER PILING - ZINC PLATED STEEL
  - PADLOCKS - KEYED ALIKE
  - CABLE LANYARDS - WIRE ROPE, STAINLESS STEEL
- 3) WEIGHT: 13 LBS
- 4) EXCEEDS:  
ASTM F2056-00 STANDARDS - IN SUITABLE SOILS

#### Finish Info.

<p>THIRD ANGLE PROJECTION</p>	<p>140 Pacific Drive Quakertown, Pa. 18951</p>	
	<p>DIMENSIONS ARE IN INCHES UNLESS OTHERWISE SPECIFIED</p>	<p>Approved By:</p> <p>Date:</p>
<p>This item is the <b>exclusive</b> property of <b>KWIK GOAL LTD.</b> Reproduction or duplication <b>without</b> the express written consent of <b>KWIK GOAL LTD.</b> is <b>strictly forbidden.</b></p>	<p>Drawn By: cspeck</p> <p>Date: 1/18/2011</p> <p>Sheet: 1 of 3</p> <p>Revision #: 1</p> <p>Cad File: 10B5303.idw</p>	<p>Desc:</p> <p>BOX ANCHORS</p>

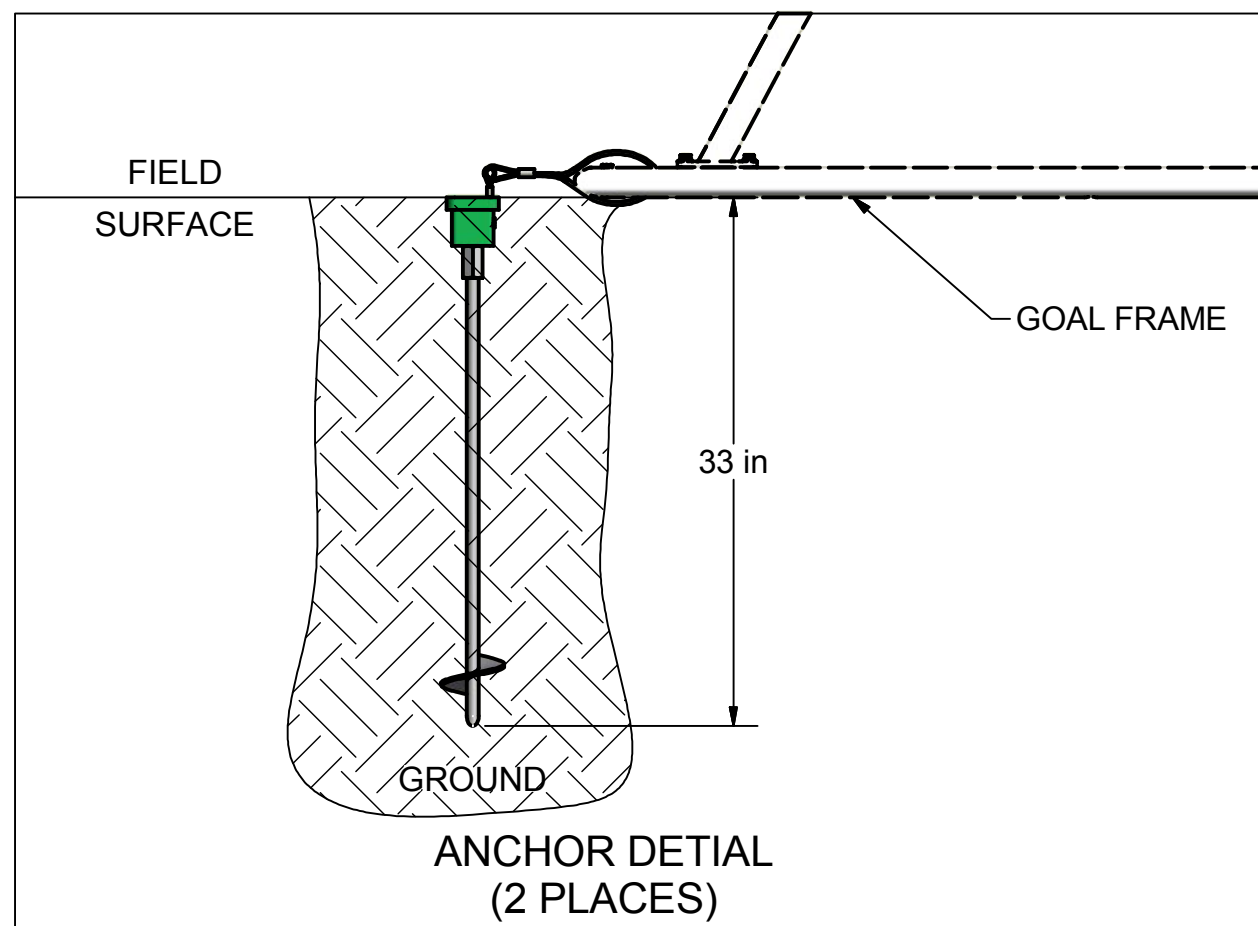
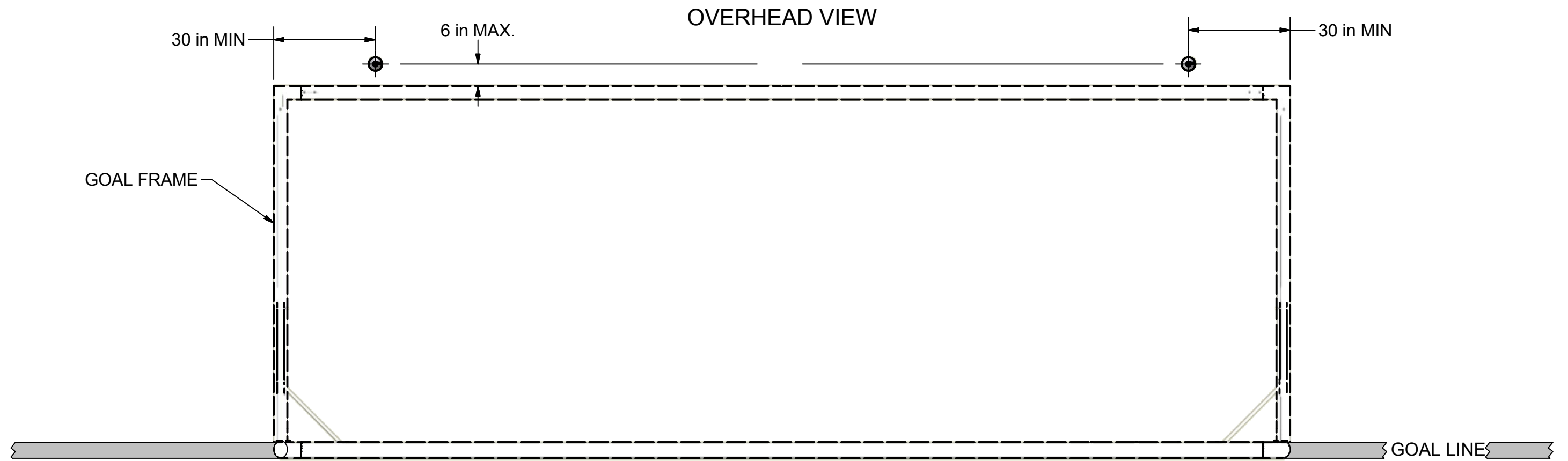

**Finish Info.**

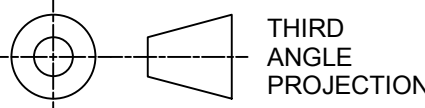
 <p>THIRD ANGLE PROJECTION</p>	 <p>140 Pacific Drive Quakertown, Pa. 18951</p>	
	<p>DIMENSIONS ARE IN INCHES UNLESS OTHERWISE SPECIFIED</p>	<p>Approved By:</p> <p>Date:</p>
<p>This item is the <b>exclusive</b> property of <b>KWIK GOAL LTD.</b> Reproduction or duplication <b>without</b> the express written consent of <b>KWIK GOAL LTD.</b> is <b>strictly forbidden.</b></p>	<p>Drawn By: cspeck</p> <p>Date: 1/18/2011</p> <p>Sheet: 2 of 3</p> <p>Revision #: 1</p> <p>Cad File: 10B5303.idw</p>	<p>Desc:</p> <p>BOX ANCHORS</p>