



IMPORTANT GOAL SAFETY INSTRUCTIONS
READ CAREFULLY

1. Check for structural integrity and proper connecting hardware before every use. Replace damaged or missing parts or fasteners immediately.
2. Safety/Warning labels must be clearly visible.
3. Securely anchor moveable soccer goals at ALL times.
4. Always instruct players, managers, coaches, trainers, teachers, maintenance workers and all other personnel who might come in contact with the goal, on the safe handling of and potential dangers associated with moveable soccer goals.
5. Always exercise extreme caution when moving goals and provide adequate manpower to move goals of varied sizes and weights. Moveable soccer goals should only be moved by authorized personnel.
6. NEVER allow anyone to climb on the net or goal framework.
7. Moveable soccer goals should only be used on LEVEL fields, NEVER on a slope or hill area.
8. Remove nets when goals are not in use.
9. Most of the tip-over injuries occurred when goals were unattended. Anchor or chain one goal to another or to nearby fence posts, dugouts, or any other similar sturdy fixture when not in use. If this is not practical, store moveable soccer goals in a place where children cannot have access to them.
10. Fully disassemble goals for seasonal storage.



Most Kwik Goal products carry a **Lifetime Guarantee**. For details or claims, visit kwikgoal.com or contact customer service at 1-800-531-4252.

ASSEMBLY INSTRUCTIONS FOR 25B06 EVOLUTION GOAL

1. Unpack all parts and check for damage that may have occurred during shipping. If damage has occurred, notify trucking company immediately. Lay out all parts. Remove all cardboard and packaging immediately. Wet or damp packaging may damage contents.
2. Read through entire instruction before beginning assembly and installation.

Rail (1)
(Part# UZ932)

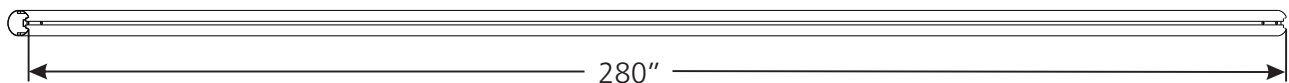

Back Bottom Bar (1)
(Part# UZ892)

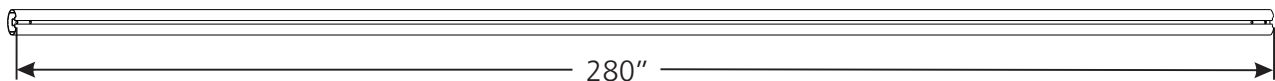

Left Post (1)
(Part# UZ863C)

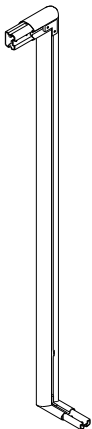

Right Post (1)
(Part# UZ864C)

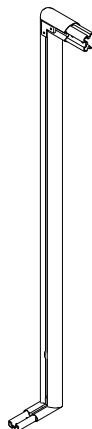

Left Base (1)
(Part# UZ890)

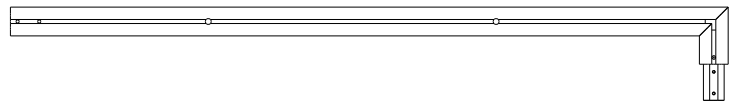

Right Base (1)
(Part# UZ891)

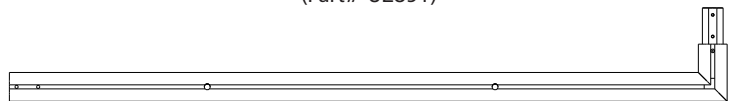

*****CAUTION*****

This goal has been designed to be used for the game of soccer only. Goal posts must be anchored AT ALL TIMES and shall be secured against overturning. Do not climb on the net or goal framework at anytime! All fastenings must be checked to insure they are fully tightened before and after each use of this product. Goal posts not in use must be disassembled and properly stored in a safe, secure area. (See included Guidelines for Moveable Soccer Goal Safety.) Assembled goal posts should not be left unattended. Remove nets when goals are not in use. Do not use this equipment during the threat of high winds. Goal posts should be checked for safety before and after each use. All warning and safety labels included with this product must be visible at all times. Any modifications to this or any Kwik Goal product will void any and all warranties.

Right Backstay (1)
(Part# UZ967)

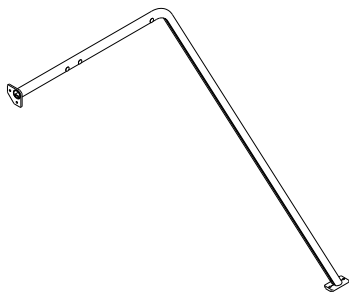

Ground Anchor (4)
w/hardware
(Part# UZ212)



Backstay Brace (2)
(Part# UZ953)

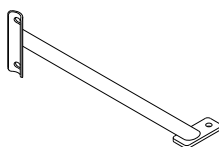

Net Strap (1)
(Part# VZ601)

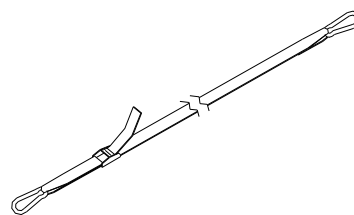

Post Brace (2)
(Part# UZ737)

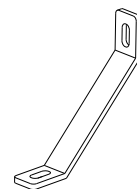

Left Backstay (1)
(Part# UZ968)

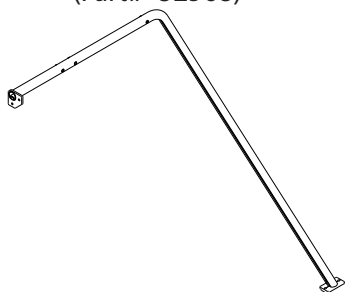

Channel Spacer (6)
(Part# UZ812)

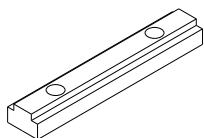

Net Clip (100)
(Part# VZ137)

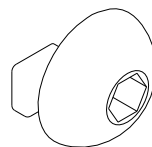

Net (1)
(Part# 3B1621)



Hardware

Note: Hardware may be packaged separately in one or more boxes. Open all packages before beginning assembly.

- 3/8" x 1 1/2" Button Head Screw (Part# TZ280) (12)
- 3/8" x 1 1/4" Button Head Screw (Part# TZ281) (8)
- 3/8" x 1" Button Head Screw (Part# TZ282) (4)
- 3/8" x 7/8" Button Head Screw (Part# TZ284) (4)
- 3/8" Lock Washer (Part# TZ65) (24)
- 3/8" Flat Washer (Part# TZ60) (24)
- 3/8" Square Nut (Part# TZ247) (8)
- 5/16" x 1" Button Head Screw (Part# TZ282) (12)
- 5/16" Eyebolt (Part# TZ120) (2)
- 5/16" Flat Washer (Part# TZ269) (6)
- 5/16" Lock Washer (Part# TZ122) (4)

Assembly Tools

1/2", 9/16" & 3/4"
Wrenches

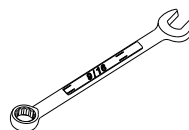

Ratchet with
1/2", 9/16" & 3/4"
Sockets

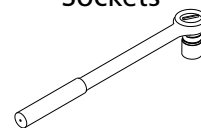

Torx Wrenches
(Part# VZ378 & VZ397)

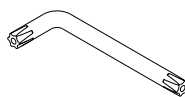

Scissors

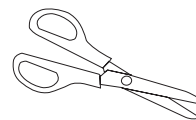

Clip Wrench
(Part# VZ140)

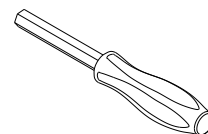

CAUTION

This goal has been designed to be used for the game of soccer only. Goal posts must be anchored AT ALL TIMES and shall be secured against overturning. Do not climb on the net or goal framework at anytime! All fastenings must be checked to insure they are fully tightened before and after each use of this product. Goal posts not in use must be disassembled and properly stored in a safe, secure area. (See included Guidelines for Moveable Soccer Goal Safety.) Assembled goal posts should not be left unattended. Remove nets when goals are not in use. Do not use this equipment during the threat of high winds. Goal posts should be checked for safety before and after each use. All warning and safety labels included with this product must be visible at all times. Any modifications to this or any Kwik Goal product will void any and all warranties.

3. Attach left post and right post to top rail using channel spacers and 3/8" x 1 1/2" button head screws. Note direction of decals on top rail before fastening. Place a 3/8" square nut in each side of the rail before inserting channel spacer. Be sure connections are pressed firmly together before tightening button head screws.
4. Insert one 3/8" square nut in slot located in each of the assembled front posts.

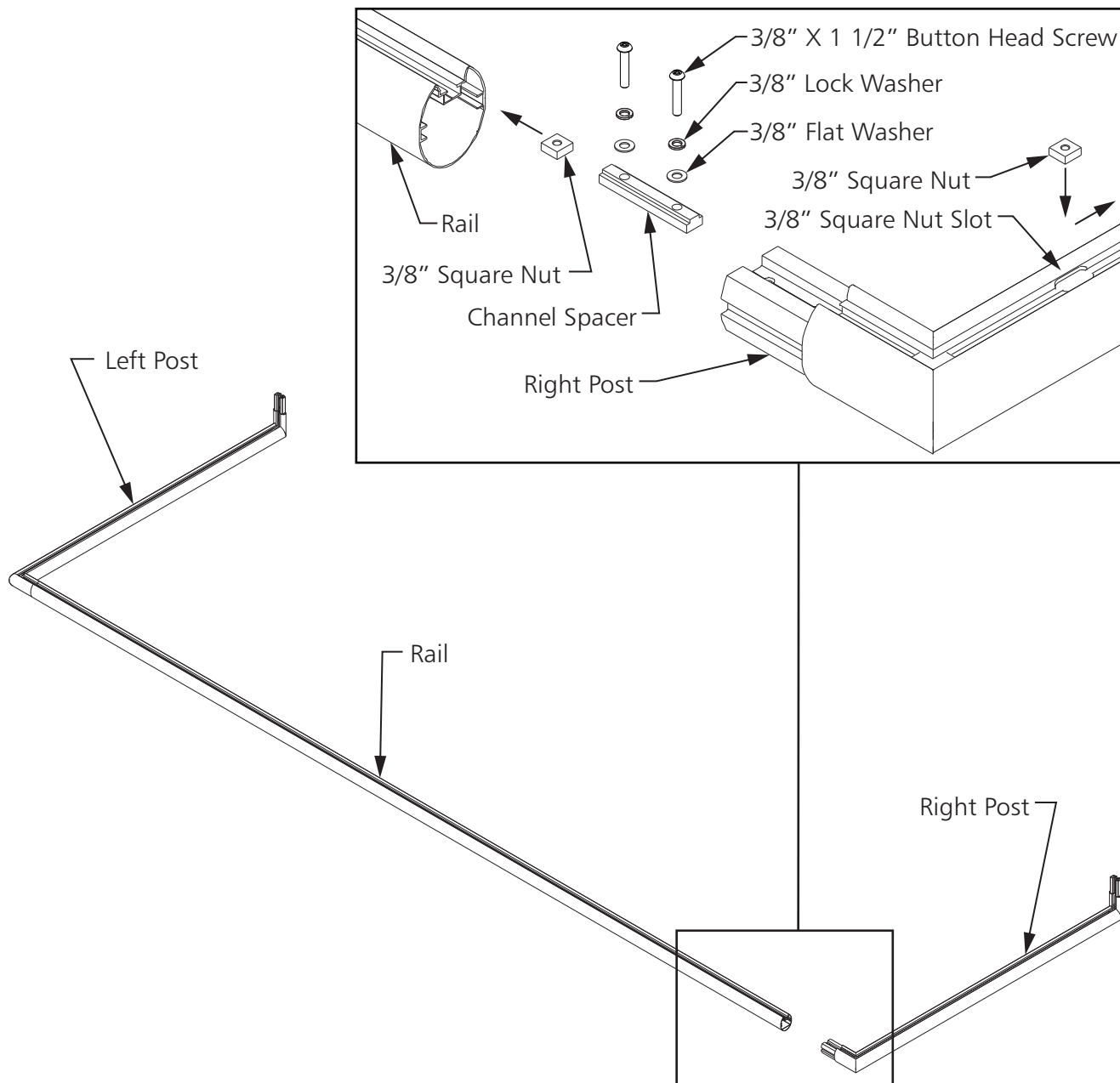

*****CAUTION*****

This goal has been designed to be used for the game of soccer only. Goal posts must be anchored AT ALL TIMES and shall be secured against overturning. Do not climb on the net or goal framework at anytime! All fastenings must be checked to insure they are fully tightened before and after each use of this product. Goal posts not in use must be disassembled and properly stored in a safe, secure area. (See included Guidelines for Moveable Soccer Goal Safety.) Assembled goal posts should not be left unattended. Remove nets when goals are not in use. Do not use this equipment during the threat of high winds. Goal posts should be checked for safety before and after each use. All warning and safety labels included with this product must be visible at all times. Any modifications to this or any Kwik Goal product will void any and all warranties.

- Attach left base and right base to back bottom bar using channel spacers and 3/8" x 1 1/2" button head screws. Note direction of decals on back bottom bar before fastening. Be sure connections are pressed firmly together before tightening button head screws.
- Insert two 3/8" square nuts into left base and right base. **NOTE: If installing optional wheels (Part# 10B403), also include two threaded channel spacers from wheel option package in each base.** To prevent threaded channel spacers or square nuts from falling out during assembly, temporarily insert a 3/8" button head screw in last threaded hole of the threaded channel spacer or square nut and finger tighten only.

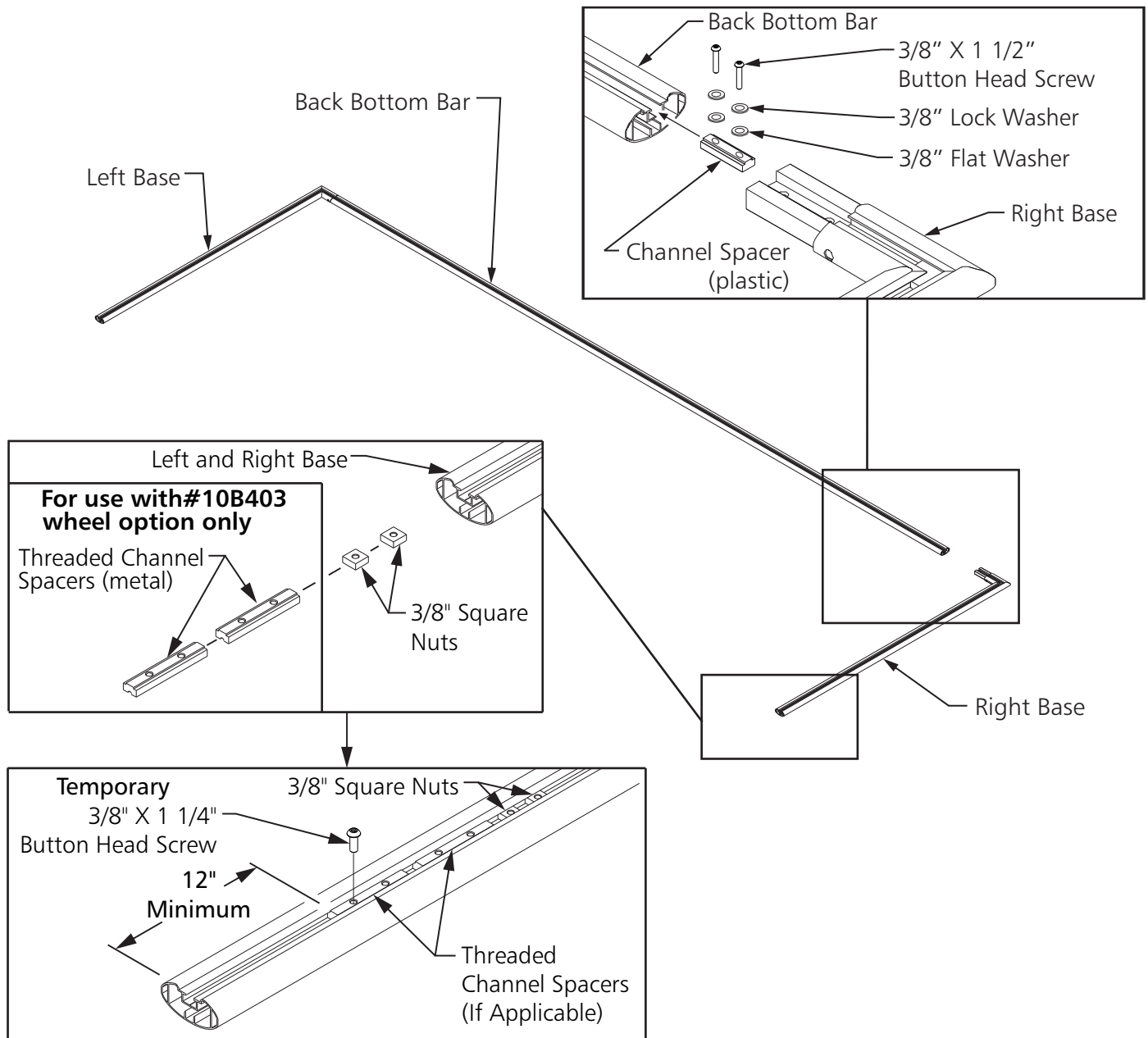

*****CAUTION*****

This goal has been designed to be used for the game of soccer only. Goal posts must be anchored AT ALL TIMES and shall be secured against overturning. Do not climb on the net or goal framework at anytime! All fastenings must be checked to insure they are fully tightened before and after each use of this product. Goal posts not in use must be disassembled and properly stored in a safe, secure area. (See included Guidelines for Moveable Soccer Goal Safety.) Assembled goal posts should not be left unattended. Remove nets when goals are not in use. Do not use this equipment during the threat of high winds. Goal posts should be checked for safety before and after each use. All warning and safety labels included with this product must be visible at all times. Any modifications to this or any Kwik Goal product will void any and all warranties.

7. Lift and insert assembled bases into assembled posts. Fasten using channel spacers, front post braces, 3/8" button head screws and 3/8" square nuts. Be sure connections are pressed firmly together before tightening button head screw.

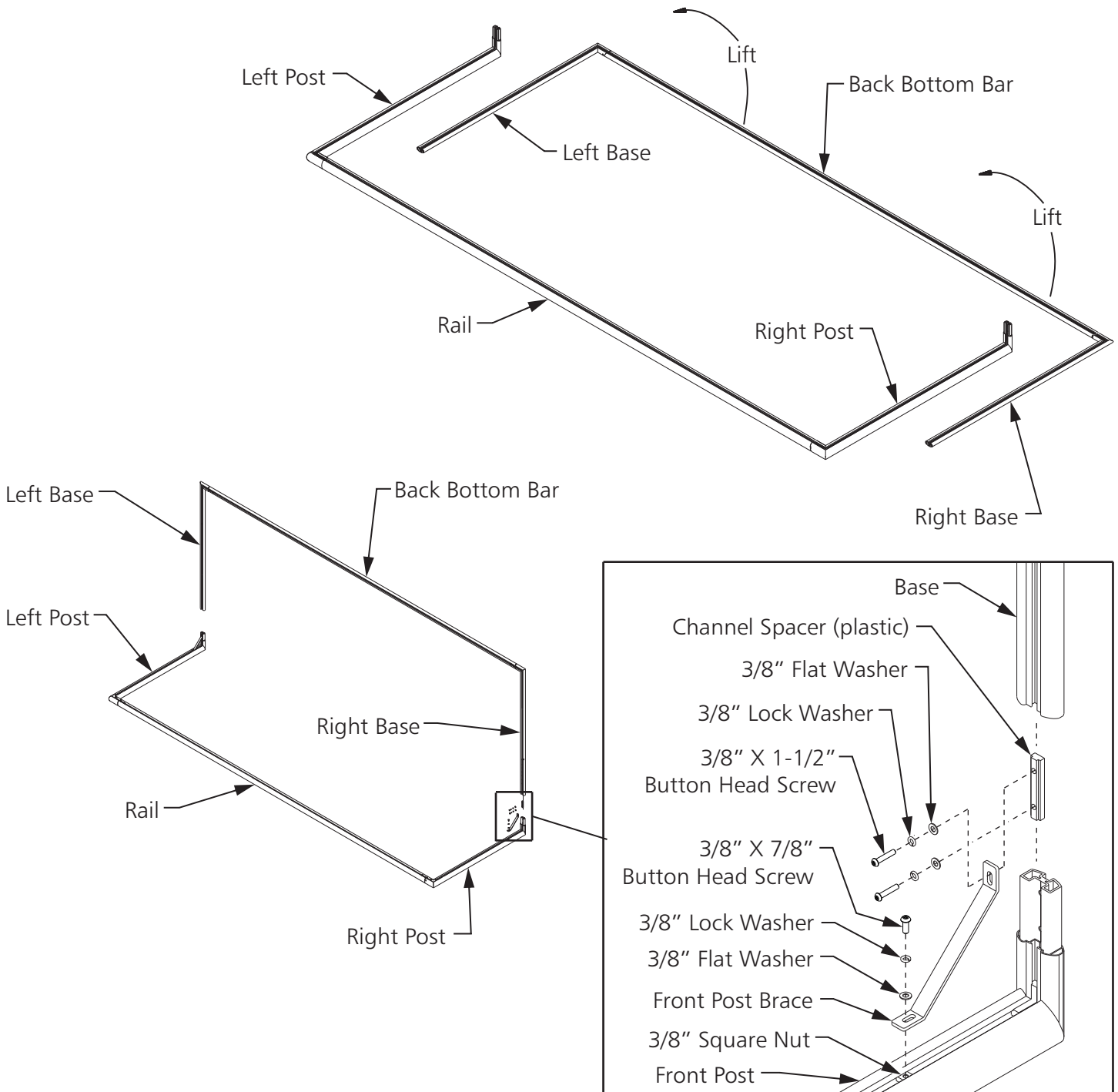

*****CAUTION*****

This goal has been designed to be used for the game of soccer only. Goal posts must be anchored AT ALL TIMES and shall be secured against overturning. Do not climb on the net or goal framework at anytime! All fastenings must be checked to insure they are fully tightened before and after each use of this product. Goal posts not in use must be disassembled and properly stored in a safe, secure area. (See included Guidelines for Moveable Soccer Goal Safety.) Assembled goal posts should not be left unattended. Remove nets when goals are not in use. Do not use this equipment during the threat of high winds. Goal posts should be checked for safety before and after each use. All warning and safety labels included with this product must be visible at all times. Any modifications to this or any Kwik Goal product will void any and all warranties.

8. Remove 3/8" button head screws used to temporarily secure fasteners to bases. Attach each backstay to goal using 3/8" x 1 1/4" button head screws..

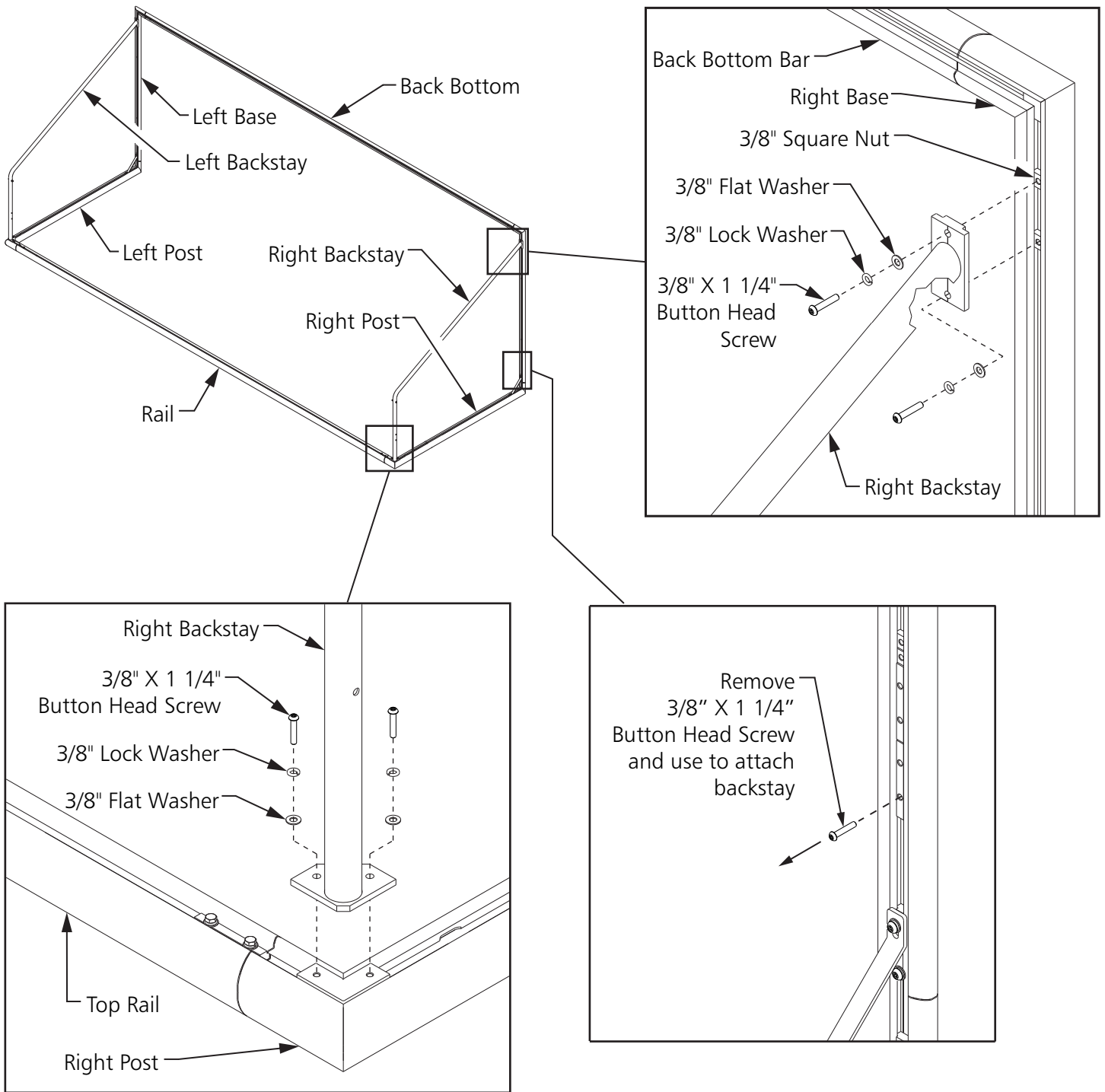

*****CAUTION*****

This goal has been designed to be used for the game of soccer only. Goal posts must be anchored AT ALL TIMES and shall be secured against overturning. Do not climb on the net or goal framework at anytime! All fastenings must be checked to insure they are fully tightened before and after each use of this product. Goal posts not in use must be disassembled and properly stored in a safe, secure area. (See included Guidelines for Moveable Soccer Goal Safety.) Assembled goal posts should not be left unattended. Remove nets when goals are not in use. Do not use this equipment during the threat of high winds. Goal posts should be checked for safety before and after each use. All warning and safety labels included with this product must be visible at all times. Any modifications to this or any Kwik Goal product will void any and all warranties.

9. Attach backstay braces using 3/8" x 7/8" button head screws, 3/8" square nuts and 5/16" x 1" button head screws. Attach eye bolts to right backstay and left backstay.

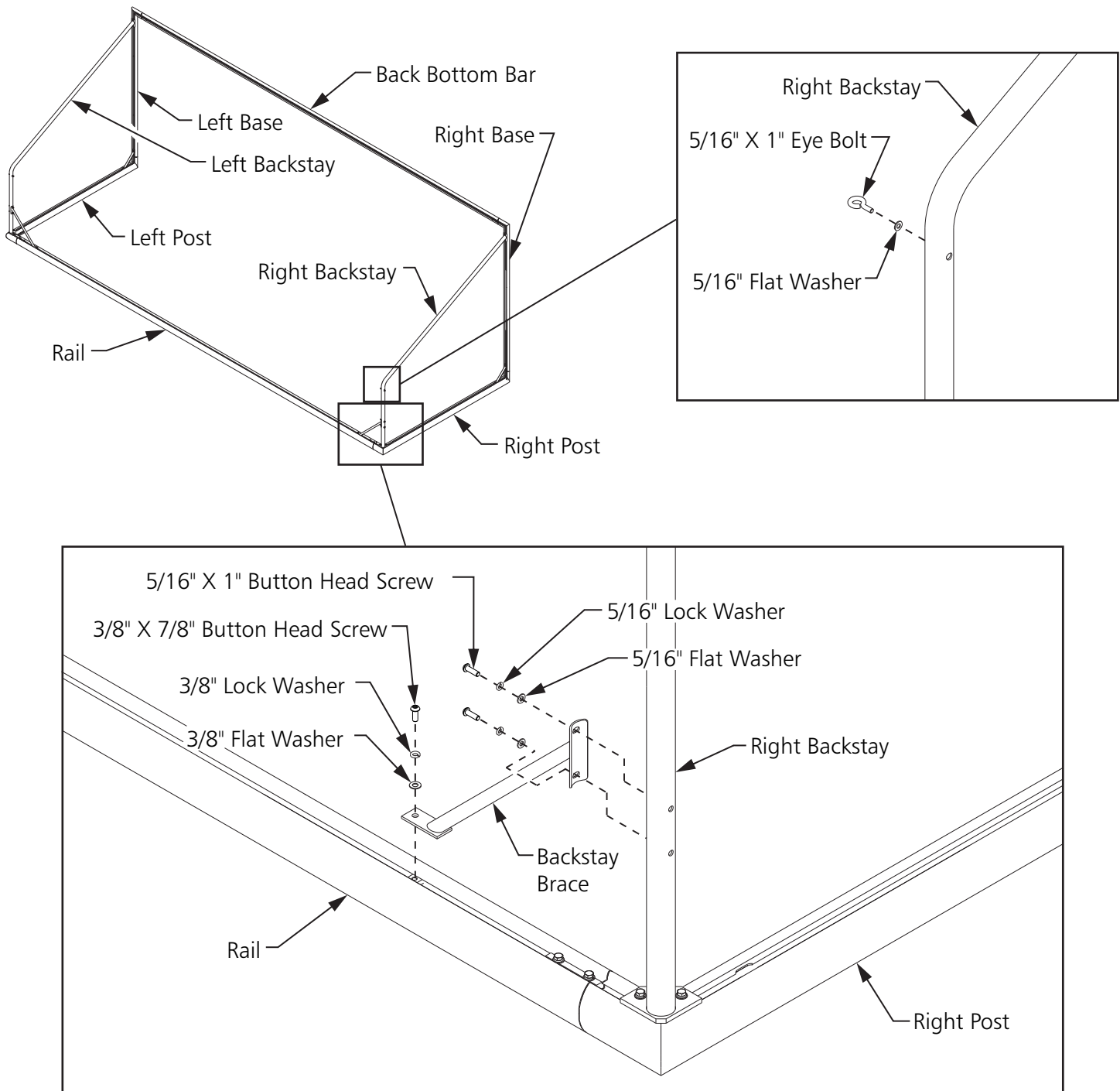

*****CAUTION*****

This goal has been designed to be used for the game of soccer only. Goal posts must be anchored AT ALL TIMES and shall be secured against overturning. Do not climb on the net or goal framework at anytime! All fastenings must be checked to insure they are fully tightened before and after each use of this product. Goal posts not in use must be disassembled and properly stored in a safe, secure area. (See included Guidelines for Moveable Soccer Goal Safety.) Assembled goal posts should not be left unattended. Remove nets when goals are not in use. Do not use this equipment during the threat of high winds. Goal posts should be checked for safety before and after each use. All warning and safety labels included with this product must be visible at all times. Any modifications to this or any Kwik Goal product will void any and all warranties.

10. Turn goal upright onto its bases. Set goal in desired area and mark ground anchor hole location.
11. Move goal and dig holes a minimum of 24" in diameter and 20" deep. Areas subject to heavy ground frost may go as deep as 36".

CAUTION: GOALS MUST BE PROPERLY ANCHORED OR STORED AT ALL TIMES.

12. Apply anti-seize compound to ground anchor bolts prior to insertion. Attach ground anchors to assembled goal and secure with coated bolts. Set goal in desired installation location with anchors in holes, fill holes surrounding anchors with concrete.
13. At this time, be sure your goal is plumb and level to field surface.

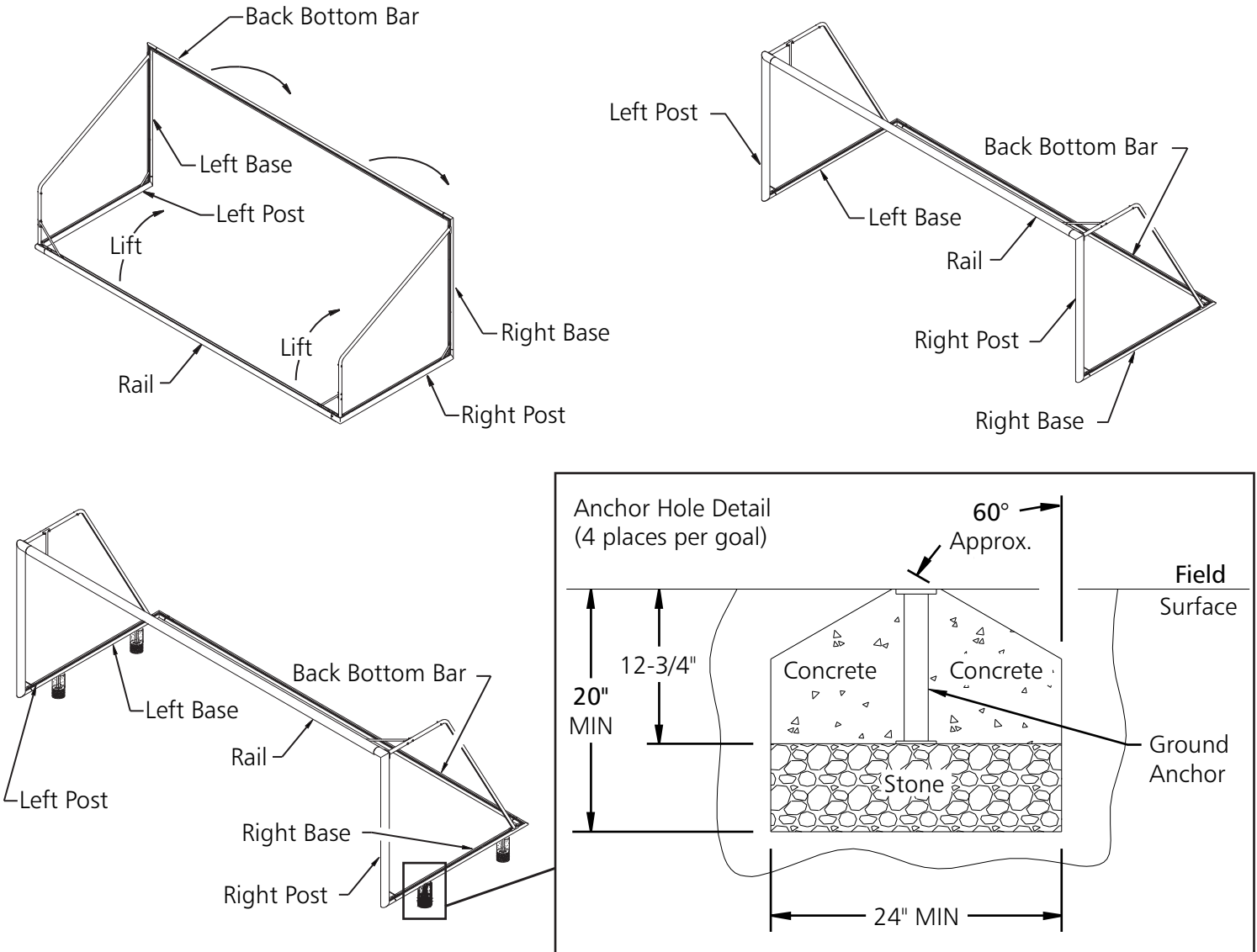

*****CAUTION*****

This goal has been designed to be used for the game of soccer only. Goal posts must be anchored AT ALL TIMES and shall be secured against overturning. Do not climb on the net or goal framework at anytime! All fastenings must be checked to insure they are fully tightened before and after each use of this product. Goal posts not in use must be disassembled and properly stored in a safe, secure area. (See included Guidelines for Moveable Soccer Goal Safety.) Assembled goal posts should not be left unattended. Remove nets when goals are not in use. Do not use this equipment during the threat of high winds. Goal posts should be checked for safety before and after each use. All warning and safety labels included with this product must be visible at all times. Any modifications to this or any Kwik Goal product will void any and all warranties.

14. The ground anchor and chain leash system supplied is the recommended and the safest method of anchoring your goal. However, counterbalance weight may be used as a temporary anchoring system. A minimum of 240 lbs. must be placed on the back bottom bar for the goal to be stabilized. Test anchoring in accordance with step 15.

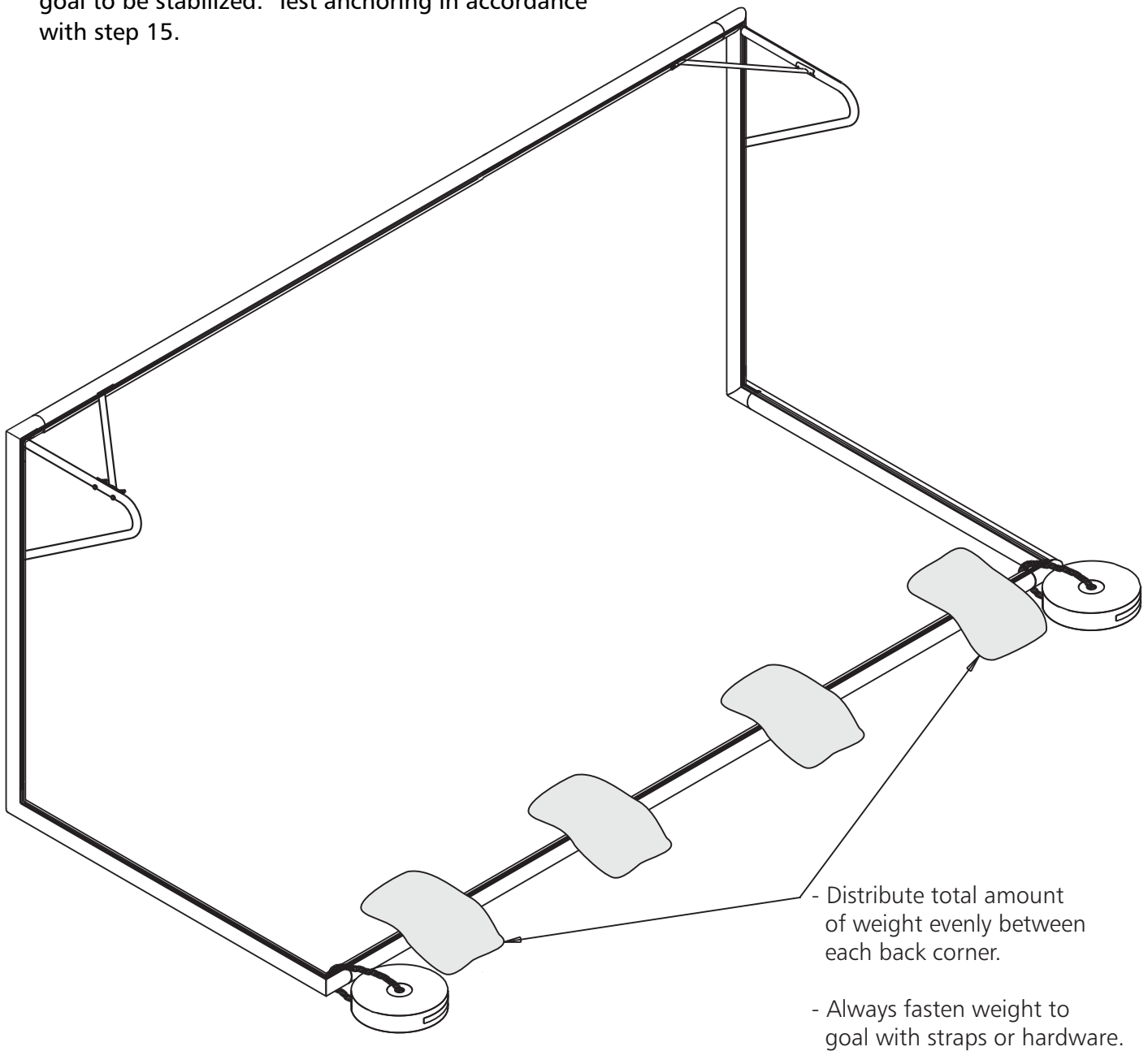

- Distribute total amount of weight evenly between each back corner.

- Always fasten weight to goal with straps or hardware.

*****CAUTION*****

This goal has been designed to be used for the game of soccer only. Goal posts must be anchored AT ALL TIMES and shall be secured against overturning. Do not climb on the net or goal framework at anytime! All fastenings must be checked to insure they are fully tightened before and after each use of this product. Goal posts not in use must be disassembled and properly stored in a safe, secure area. (See included Guidelines for Moveable Soccer Goal Safety.) Assembled goal posts should not be left unattended. Remove nets when goals are not in use. Do not use this equipment during the threat of high winds. Goal posts should be checked for safety before and after each use. All warning and safety labels included with this product must be visible at all times. Any modifications to this or any Kwik Goal product will void any and all warranties.

15. After concrete has fully cured, follow test procedures to assure that goal has been anchored properly.

ANCHOR TEST

1. Clear all persons from a minimum 50 foot radius surrounding the goal.
2. Verify goal is attached to anchors according to instruction.
3. Apply a horizontal pull force of 247 lbs. to the center of the rail for 60 - 70 seconds. Full safety precautions must be taken while performing test.
4. If goal overturns during application of force or does not return to an upright position after removing force, an alternate anchoring system must be used

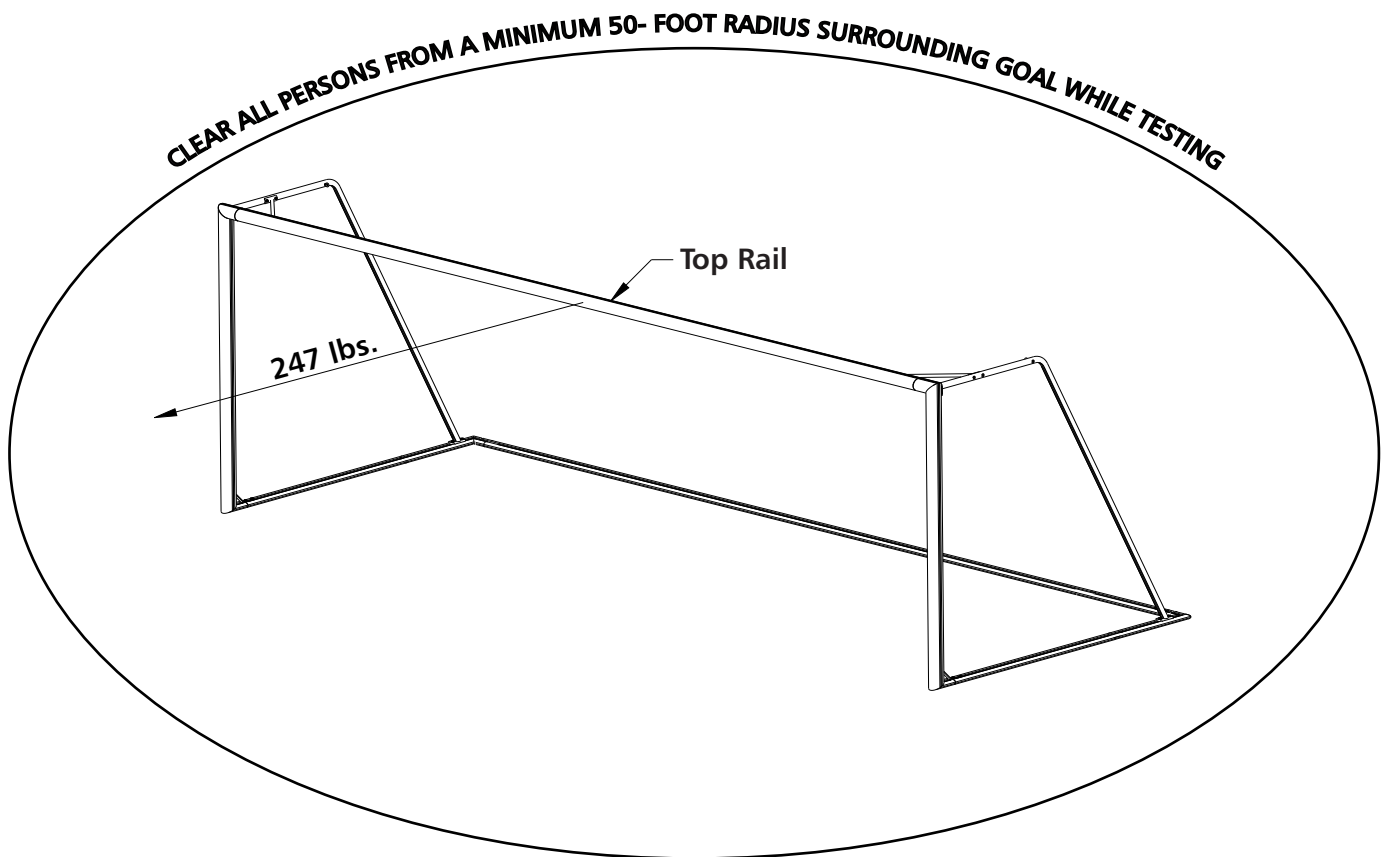

CAUTION

This goal has been designed to be used for the game of soccer only. Goal posts must be anchored AT ALL TIMES and shall be secured against overturning. Do not climb on the net or goal framework at anytime!

All fastenings must be checked to insure they are fully tightened before and after each use of this product. Goal posts not in use must be disassembled and properly stored in a safe, secure area. (See included Guidelines for Moveable Soccer Goal Safety.) Assembled goal posts should not be left unattended. Remove nets when goals are not in use. Do not use this equipment during the threat of high winds. Goal posts should be checked for safety before and after each use. All warning and safety labels included with this product must be visible at all times. Any modifications to this or any Kwik Goal product will void any and all warranties.

16. Attach net using net clips and clip wrench.

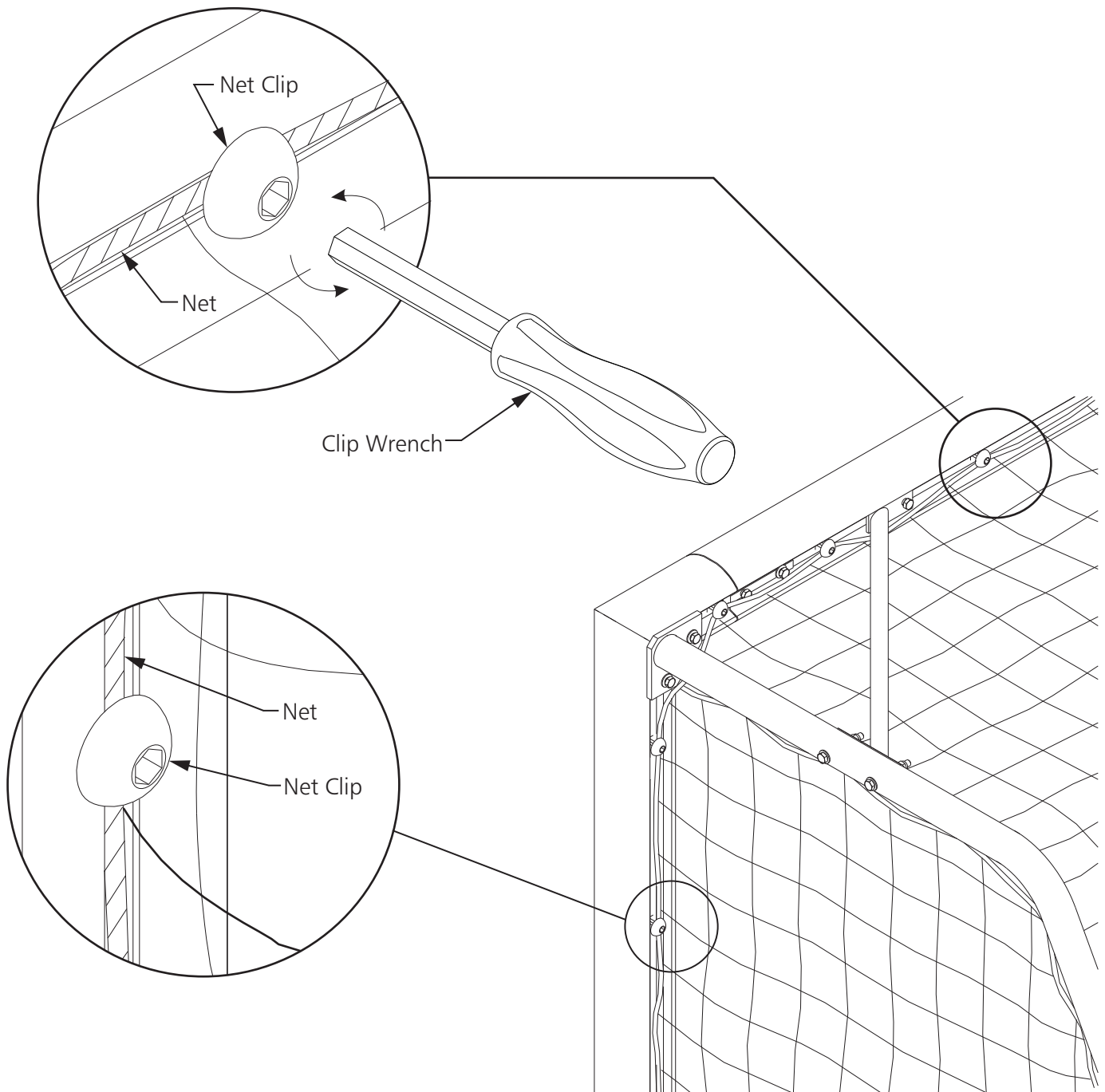

*****CAUTION*****

This goal has been designed to be used for the game of soccer only. Goal posts must be anchored AT ALL TIMES and shall be secured against overturning. Do not climb on the net or goal framework at anytime!

All fastenings must be checked to insure they are fully tightened before and after each use of this product. Goal posts not in use must be disassembled and properly stored in a safe, secure area. (See included Guidelines for Moveable Soccer Goal Safety.) Assembled goal posts should not be left unattended. Remove nets when goals are not in use. Do not use this equipment during the threat of high winds. Goal posts should be checked for safety before and after each use. All warning and safety labels included with this product must be visible at all times. Any modifications to this or any Kwik Goal product will void any and all warranties.

17. From inside goal frame, attach net strap to the eyebolts in the backstays as shown. Pull net strap tight as shown. **(NOTE: Do not over tighten net strap. Over tightening may damage goal.)** Excess strap can be trimmed to length. Leave 12" to 18" of excess strap for ease of removal and re-installation. (Note: To keep end of adjustable strap from fraying, ends can be melted after being cut.) Tie all excess strap to itself to prevent from hanging in goal area.

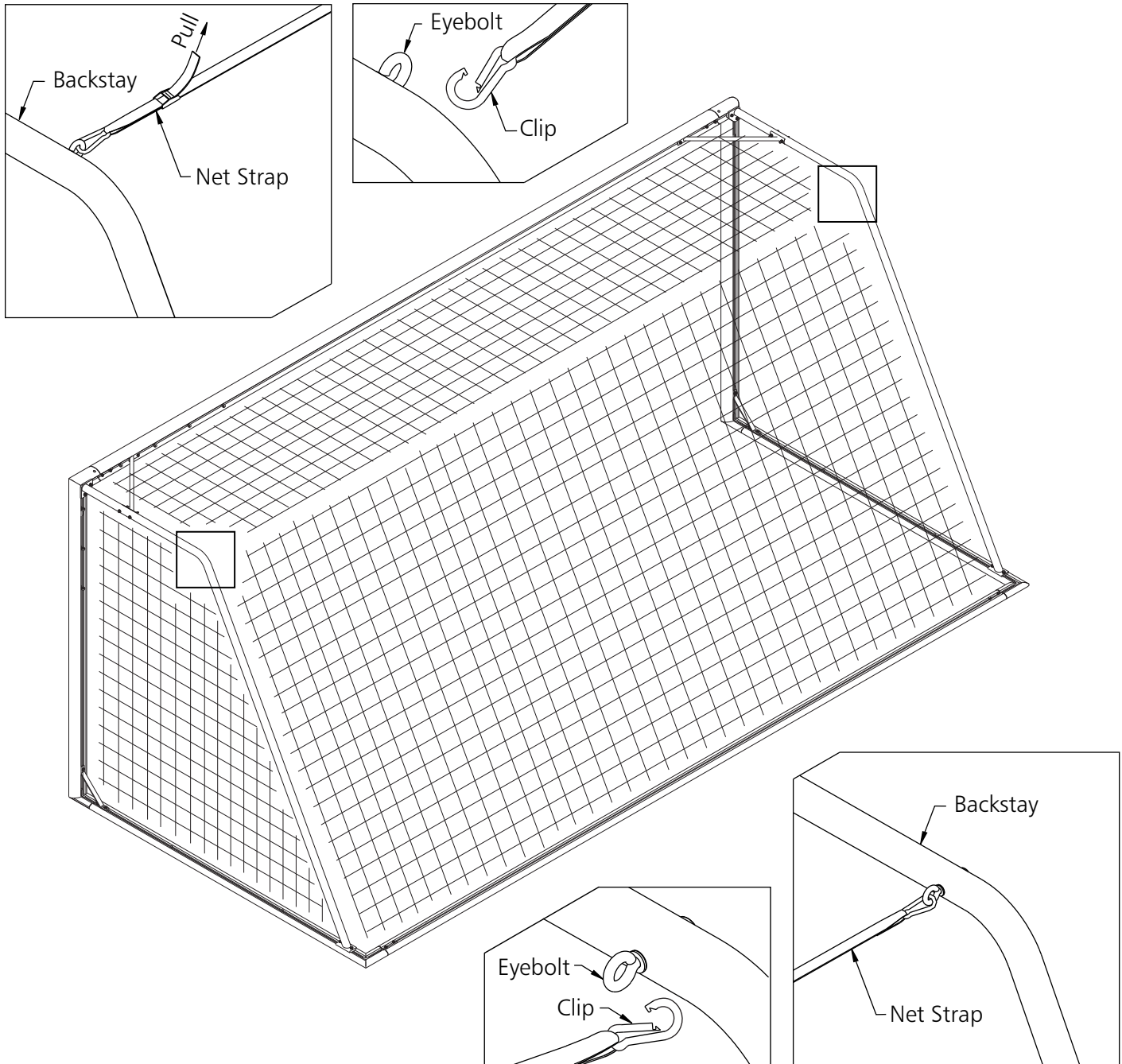

*****CAUTION*****

This goal has been designed to be used for the game of soccer only. Goal posts must be anchored AT ALL TIMES and shall be secured against overturning. Do not climb on the net or goal framework at anytime! All fastenings must be checked to insure they are fully tightened before and after each use of this product. Goal posts not in use must be disassembled and properly stored in a safe, secure area. (See included Guidelines for Moveable Soccer Goal Safety.) Assembled goal posts should not be left unattended. Remove nets when goals are not in use. Do not use this equipment during the threat of high winds. Goal posts should be checked for safety before and after each use. All warning and safety labels included with this product must be visible at all times. Any modifications to this or any Kwik Goal product will void any and all warranties.