

FRONT VIEW

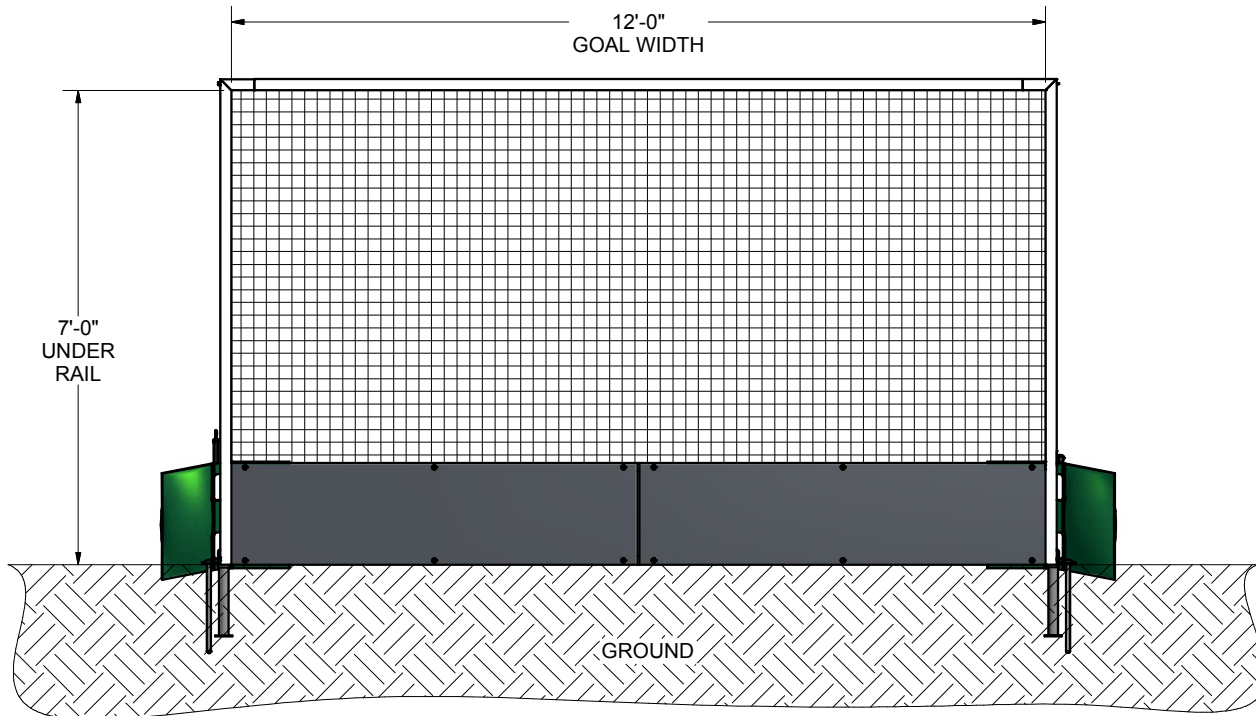

SIDE VIEW

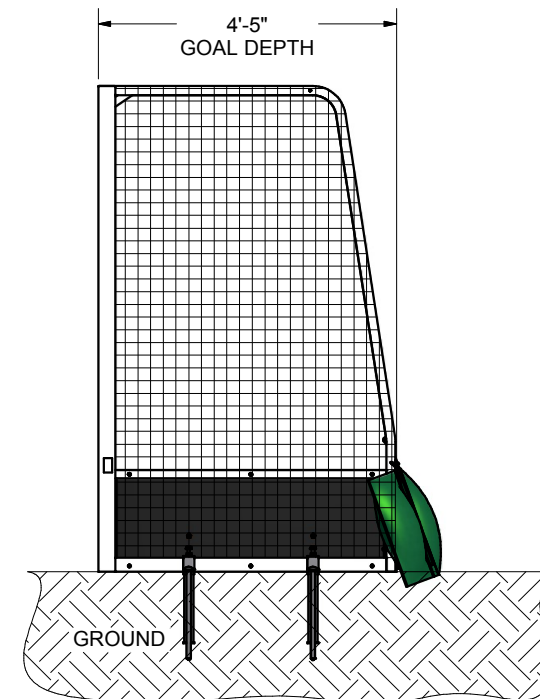

FEATURES:

1) ALUMINUM GOAL FRAME WITH ADVAN TECH® BOTTOM BOARDS

2) FINISH:

GOAL FRAME - WHITE POWDER COAT

BOTTOM BOARDS - PAINTED BLACK

3) INCLUDED:

SEMI PERMANENT GROUND ANCHORS (4)

GROUND ANCHOR PEGS (4)

SADDLE ANCHOR BAGS (4)

2.5 mm, BLACK NET

TAMPER RESISTANT NET CLIPS

4) ASSEMBLED WEIGHT:

GOAL: 185 LBS.

5) EXCEEDS:

NCAA SPECIFICATIONS

NFSHA SPECIFICATIONS

FIH SPECIFICATIONS

Finish Info.

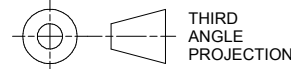

THIRD ANGLE PROJECTION



DIMENSIONS ARE IN INCHES UNLESS OTHERWISE SPECIFIED

This item is the **exclusive** property of **KWIK GOAL LTD.** Reproduction or duplication **without** the express written consent of **KWIK GOAL LTD.** is **strictly forbidden.**

Approved By:

Date:

Drawn By: cspeck

Date: 9/1/2009

Sheet: 1 of 4

Revision #: 1

Cad File: 2F501.idw

Part #:

2F501

Desc:
7' X 12' OFFICIAL FIELD HOCKEY GOAL

OVERHEAD VIEW

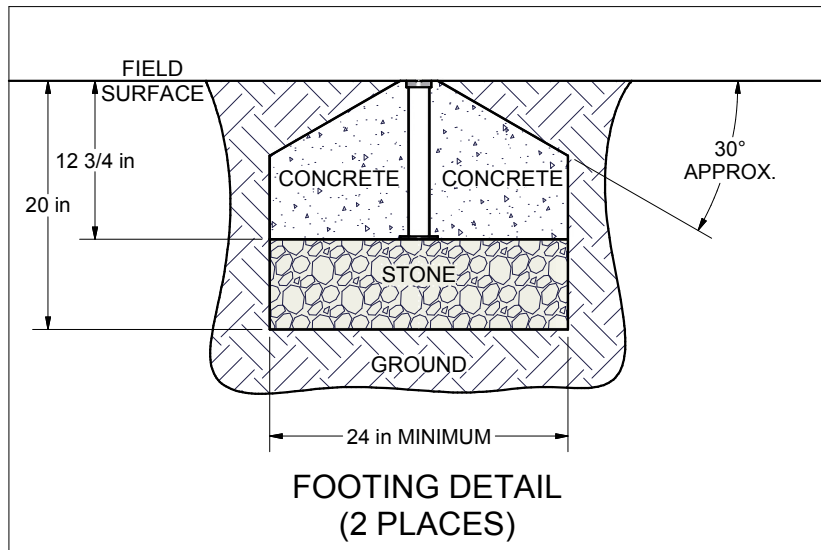
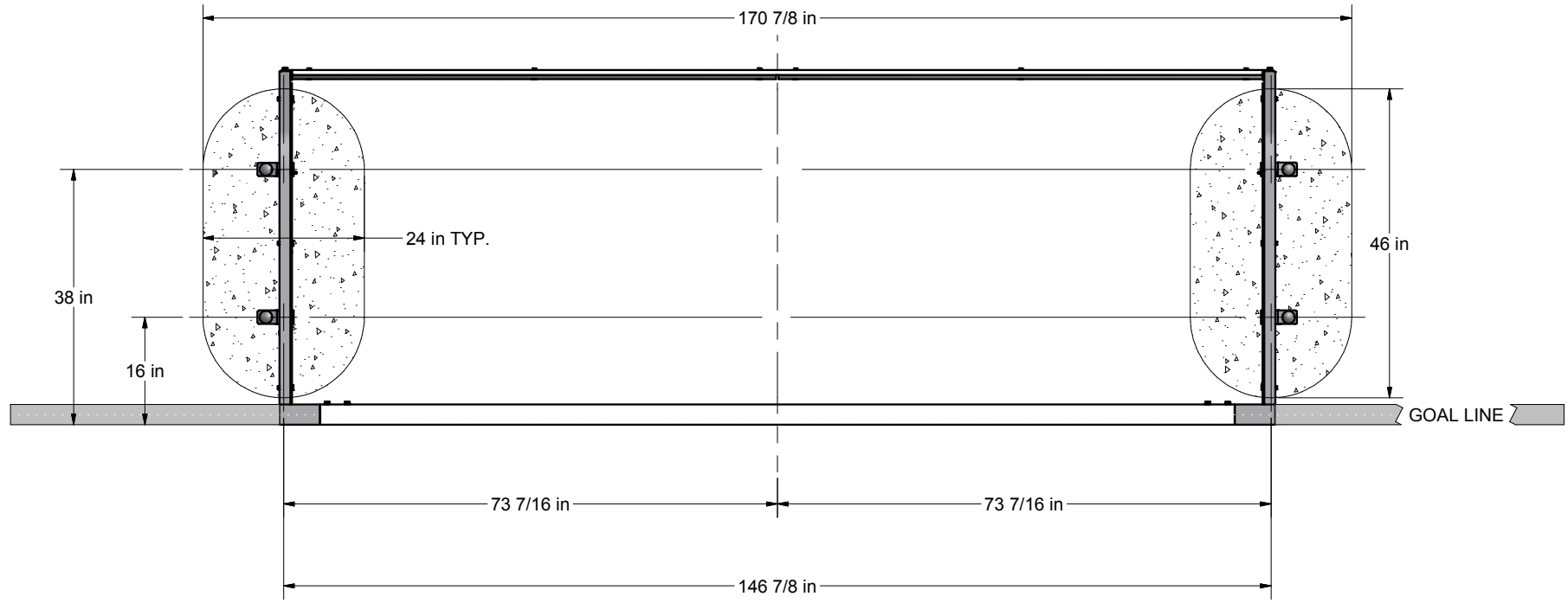



NOTES:

- 1) DIMENSIONS ARE FOR PLANNING PURPOSES. INSTALLATION MUST BE IN ACCORDANCE WITH INSTALLATION INSTRUCTIONS.

MATERIAL REQUIRED, BUT **NOT** SUPPLIED

- 0.6 cubic yard - CONCRETE
 - 0.3 cubic yard - CLEAN STONE (1/4" - 3/4")
- ABOVE AMOUNTS ARE PER GOAL INSTALLATION

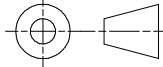
Finish Info.

| | | |
|--|--|---|
|  <p>THIRD ANGLE PROJECTION</p> |  <p>140 Pacific Drive Quakertown, Pa. 18951</p> | |
| | <p>DIMENSIONS ARE IN INCHES UNLESS OTHERWISE SPECIFIED</p> | <p>Approved By:</p> <p>Date:</p> |
| <p>This item is the exclusive property of KWIK GOAL LTD. Reproduction or duplication without the express written consent of KWIK GOAL LTD. is strictly forbidden.</p> | <p>Drawn By: cspeck</p> <p>Date: 9/1/2009</p> <p>Sheet: 2 of 4</p> <p>Revision #: 1</p> <p>Cad File: 2F501.idw</p> | <p>Desc:</p> <p>7' X 12' OFFICIAL FIELD HOCKEY GOAL</p> |

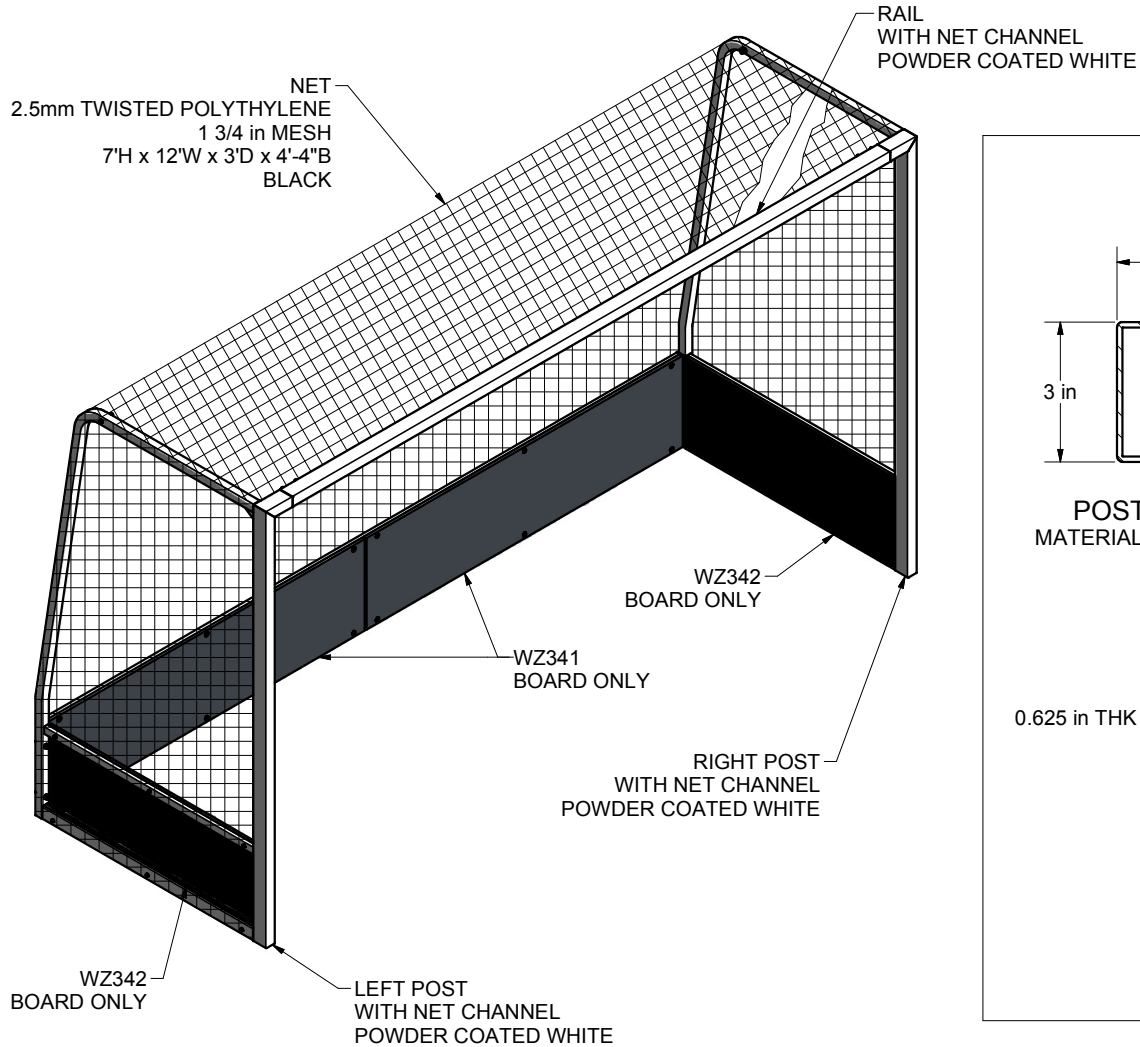

MATERIAL DETAILS

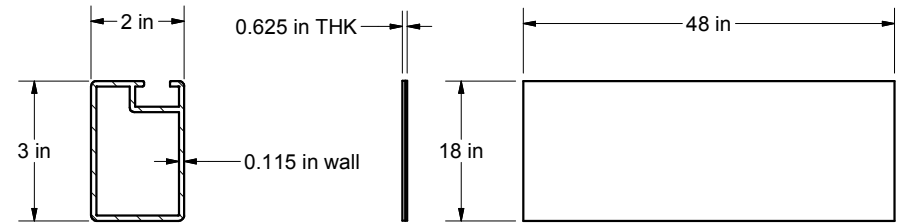

POST & RAIL
MATERIAL - ALUMINUM

SIDE BOTTOM BOARD (WZ342)
MATERIAL - WOOD COMPOSITE

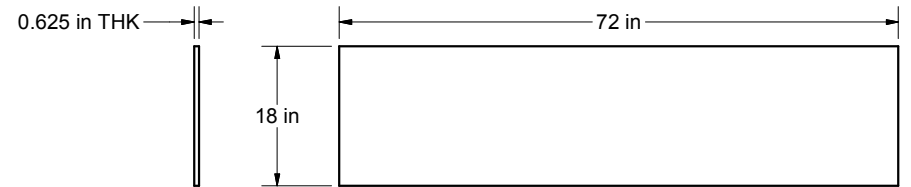

BACK BOTTOM BOARD (WZ341)
MATERIAL - WOOD COMPOSITE

Finish Info.

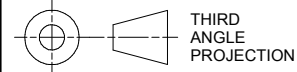

DIMENSIONS ARE IN INCHES
UNLESS OTHERWISE SPECIFIED

This item is the **exclusive**
property of **KWIK GOAL LTD.**
Reproduction or duplication
without the express written
consent of **KWIK GOAL LTD.**
is **strictly forbidden.**



Approved By:

Date:

Drawn By: cspeck

Date: 9/1/2009

Sheet: 3 of 4

Revision #: 1

Cad File: 2F501.idw

Part #:

2F501

Desc:

7' X 12' OFFICIAL FIELD
HOCKEY GOAL

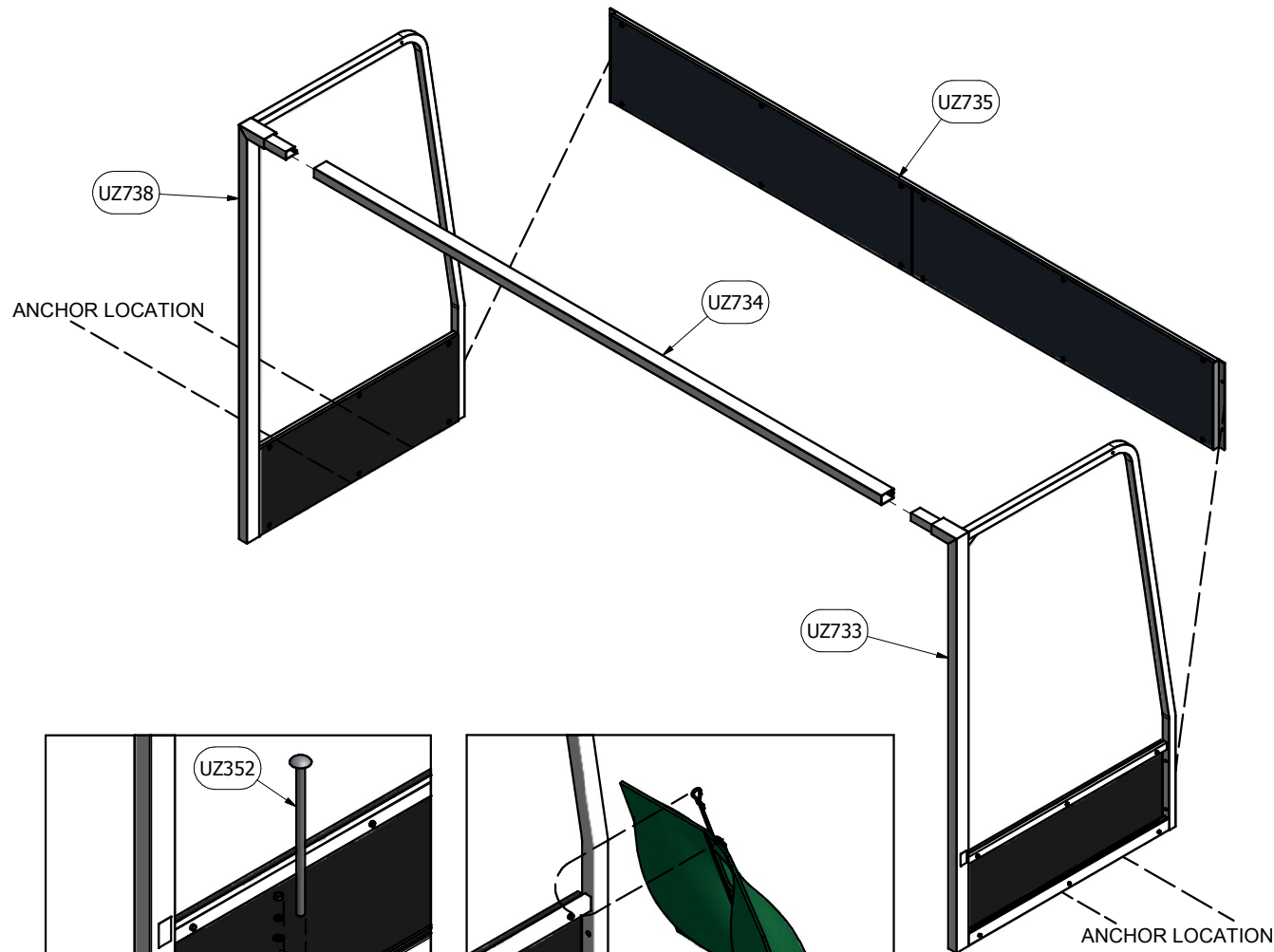

| Parts List | | |
|------------|-----|------------------------------|
| Part # | Qty | Description |
| UZ733 | 1 | RIGHT ARM, 2F501 |
| UZ738 | 1 | LEFT ARM, 2F501 |
| UZ735 | 1 | 2F501 BACK BOARD ASSEMBLY |
| UZ734 | 1 | 2F501 RAIL |
| UZ727 | 4 | GROUND ANCHOR ASSEMBLY |
| UZ736 | 4 | FIELD HOCKEY ANCHOR PLATE |
| UZ352 | 4 | 16" GROUND ANCHOR PEG |
| 3F501 | 1 | NET, 2.5MM ROPE, 1-3/4" MESH |
| 10B1605 | 2 | SADDLE ANCHOR BAG |

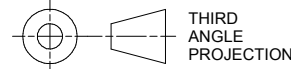
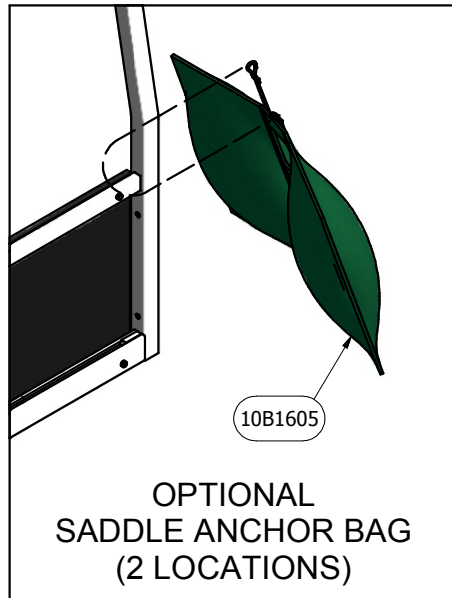
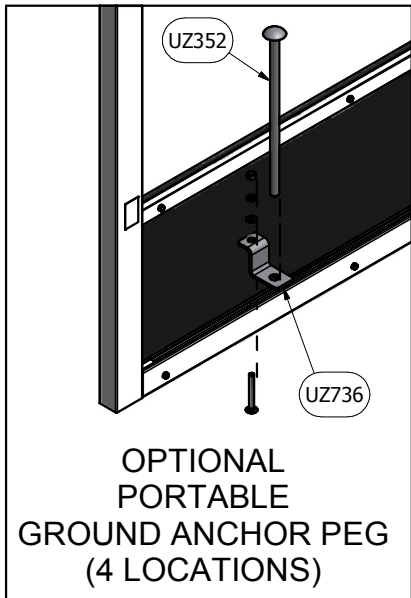
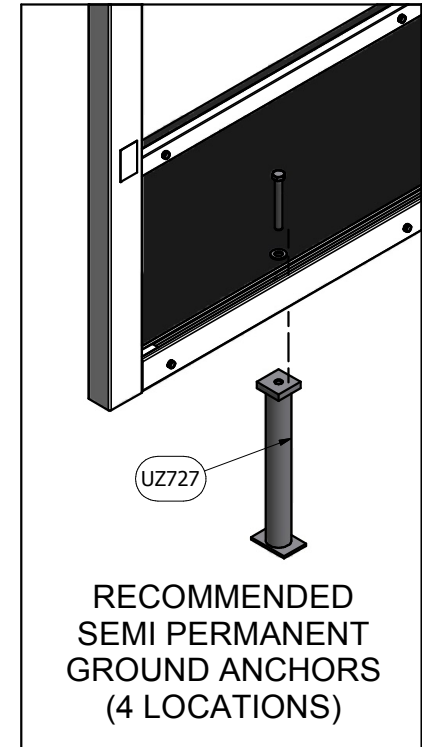

THIRD
ANGLE
PROJECTION

KWIKGOAL® 140 Pacific Drive
Quakertown,
Pa. 18951

DIMENSIONS ARE IN INCHES
UNLESS OTHERWISE SPECIFIED

Approved By:

Part #:

Date:

2F501

Drawn By: cspeck

Date: 9/1/2009

Desc:

Sheet: 4 of 4

7' X 12' OFFICIAL FIELD
HOCKEY GOAL

Revision #: 1

Cad File: 2F501.idw

This item is the **exclusive**
property of **KWIK GOAL LTD.**
Reproduction or duplication
without the express written
consent of **KWIK GOAL LTD.**
is **strictly forbidden.**

Finish Info.