



All Kwik Goal products carry a **Lifetime Guarantee**. For help with guarantee issues, visit kwikgoal.com and click on the **Lifetime Guarantee** logo or contact customer service at 1-800-531-4252.

ASSEMBLY INSTRUCTIONS FOR 2E501 LEAGUE LACROSSE GOAL

1. Unpack all parts and check for damage that may have occurred during shipping. If damage has occurred, notify trucking company immediately. Lay out all parts. Remove all cardboard and packaging immediately. Wet or damp packaging may damage contents.
2. Read through entire instruction before beginning assembly and installation.

Parts

Top Tube (1)
(Part# UZ1243)

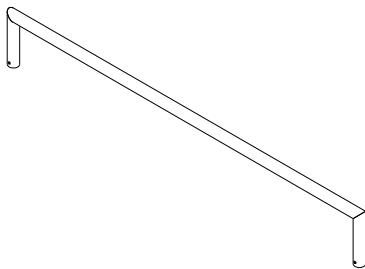

Base Tube (2)
(Part# UZ1245)

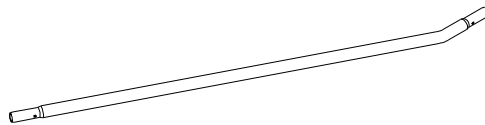

Rear Tube (1)
(Part# UZ1246)



Post Tube (2)
(Part# UZ1244)

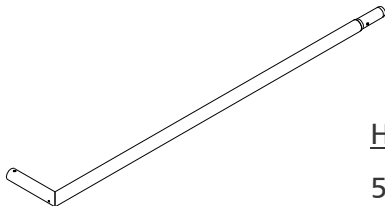

Net (1)
(Part# LCN-300)

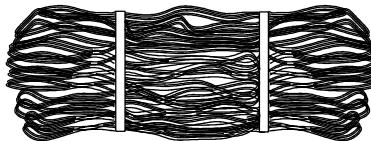

J - Anchor Peg (4)
(Part# 10B9001-Set of 4)

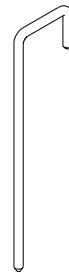

Hardware

5/16" X 2 1/4" Carriage Bolt (Part# TZ322) (6)
5/16" Lock Nut (Part# TZ321) (6)

*****CAUTION*****

This equipment has been designed to be used for the game of lacrosse only. Field equipment must be anchored AT ALL TIMES and shall be secured against tilting. Do not climb on the net or equipment framework at anytime! All fastenings must be checked to insure they are fully tightened before and after each use of this product. Equipment not in use must be disassembled and properly stored in a safe, secure area. Assembled Field equipment should not be left unattended. Remove nets when equipment is not in use. Do not use this equipment during the threat of high winds. Field equipment must be checked for safety before and after each use. All warning and safety labels included with this product must be visible at all times. Any modifications to this or any Kwik Goal product will void any and all warranties.

140 Pacific Drive Quakertown, PA 18951
(P) 215-536-2200 / (P) 800-531-4252 / (F) 215-536-4309 / (F) 800-778-8869
Visit our website @ kwikgoal.com
© 2011 Kwik Goal Ltd.

2. Assemble goal frame as shown.

Note: Keep heads of carriage bolts to the outside of goal frame.

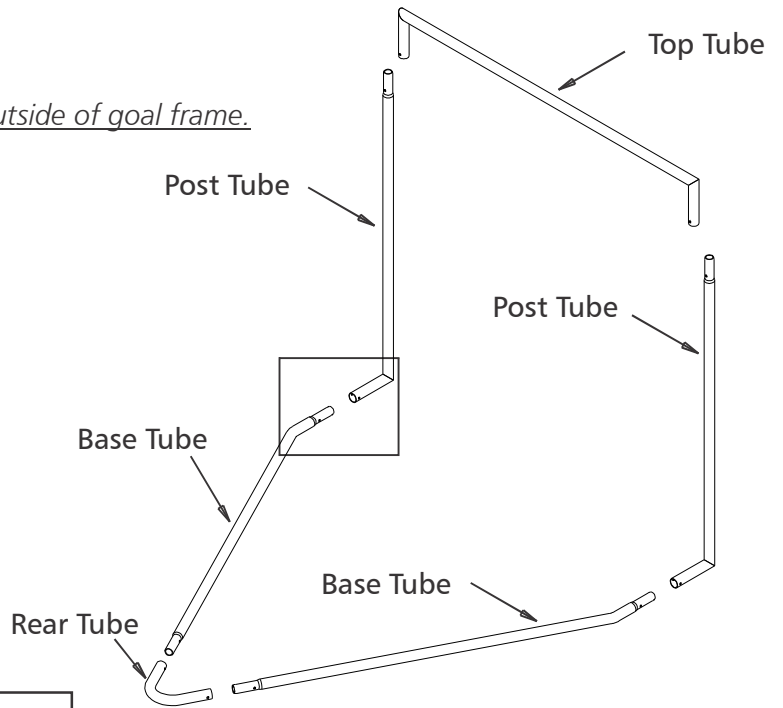
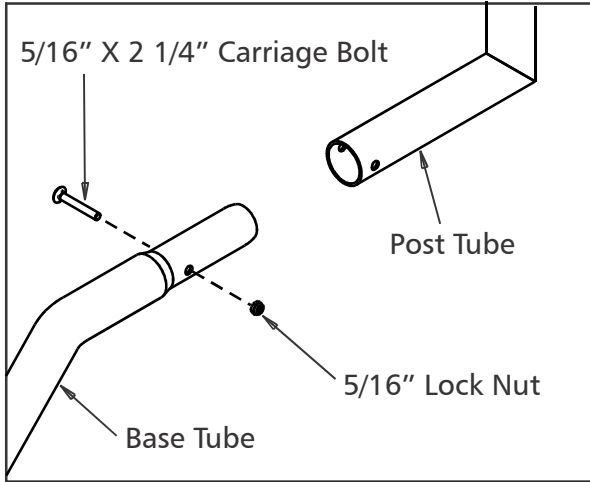

4. Attach net by weaving rope through every other mesh of the net perimeter. Continue around entire goal frame.

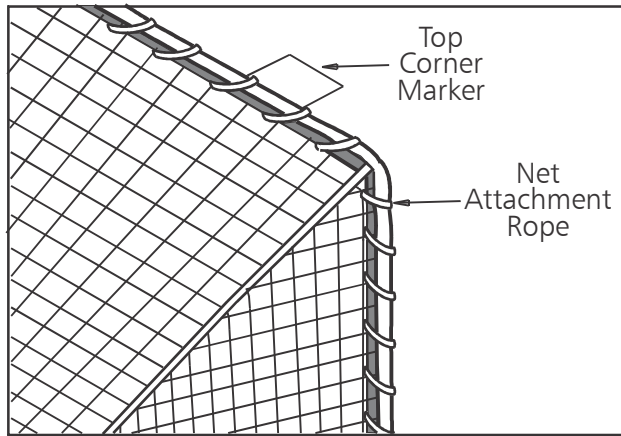

5. Anchor goal with J - anchor pegs as shown.

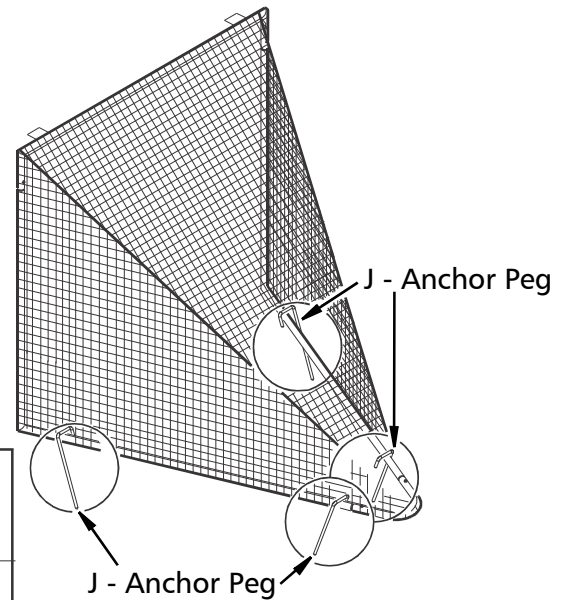
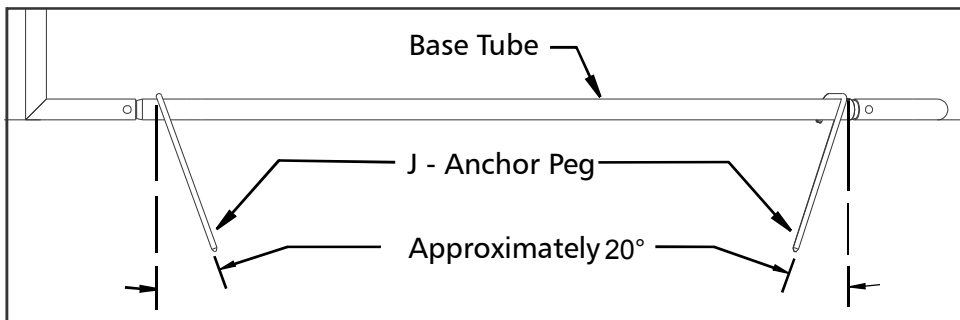

*****CAUTION*****

This equipment has been designed to be used for the game of lacrosse only. Field equipment must be anchored AT ALL TIMES and shall be secured against tilting. Do not climb on the net or equipment framework at anytime! All fastenings must be checked to insure they are fully tightened before and after each use of this product. Equipment not in use must be disassembled and properly stored in a safe, secure area. Assembled Field equipment should not be left unattended. Remove nets when equipment is not in use. Do not use this equipment during the threat of high winds. Field equipment must be checked for safety before and after each use. All warning and safety labels included with this product must be visible at all times. Any modifications to this or any Kwik Goal product will void any and all warranties.