

FEATURES:

- 1) ALUMINUM FRAME CONSTRUCTION WITH STEEL GROUND SHOES.
- 2) COLOR CODED KWIK BUTTON ASSEMBLY.
- 3) FINISH: MILL
- 4) INCLUDED:
 - 3mm, 4" MESH, BLACK NET WITH MOVEABLE TARGET
 - BUNGEEES FOR NET ATTACHMENT
- 5) ASSEMBLED GOAL WEIGHT: 45 LBS.

Finish Info.

 THIRD ANGLE PROJECTION	 KWIKGOAL [®] 140 Pacific Drive Quakertown, Pa. 18951	
	DIMENSIONS ARE IN INCHES UNLESS OTHERWISE SPECIFIED	Approved By: Date:
This item is the exclusive property of KWIK GOAL LTD. Reproduction or duplication without the express written consent of KWIK GOAL LTD. is strictly forbidden.	Drawn By: jwillenbecher Date: 8/7/2012 Sheet: 1 of 4 Revision #: 5 Cad File: 2B1603.idw	Desc: AFR-1 REBOUNDER

OVERHEAD VIEW

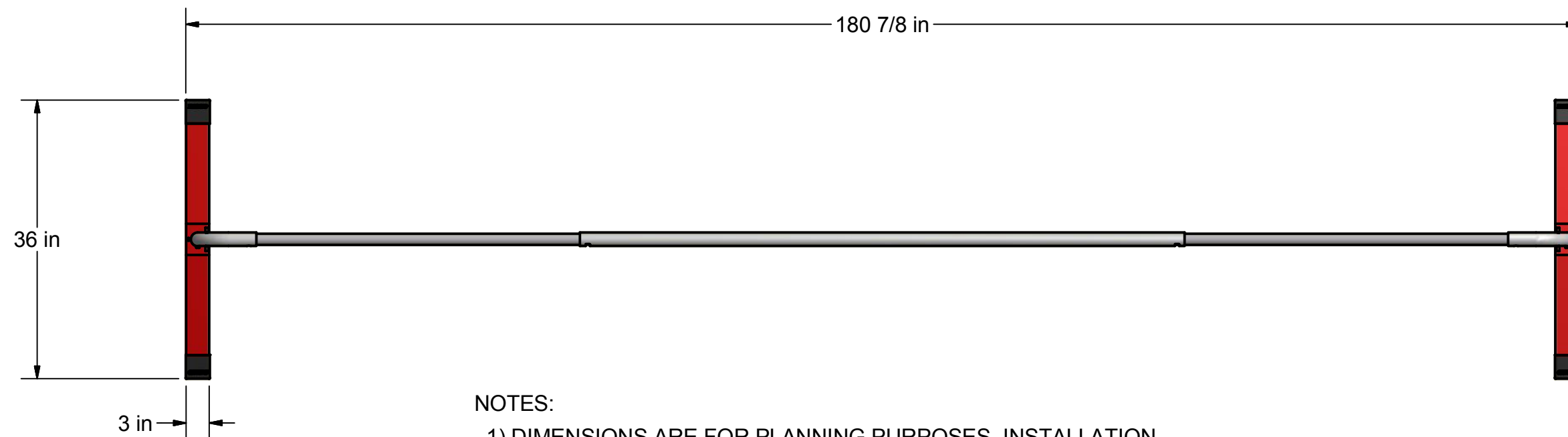

NOTES:

- 1) DIMENSIONS ARE FOR PLANNING PURPOSES. INSTALLATION MUST BE IN ACCORDANCE WITH INSTALLATION INSTRUCTIONS.

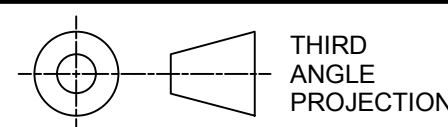
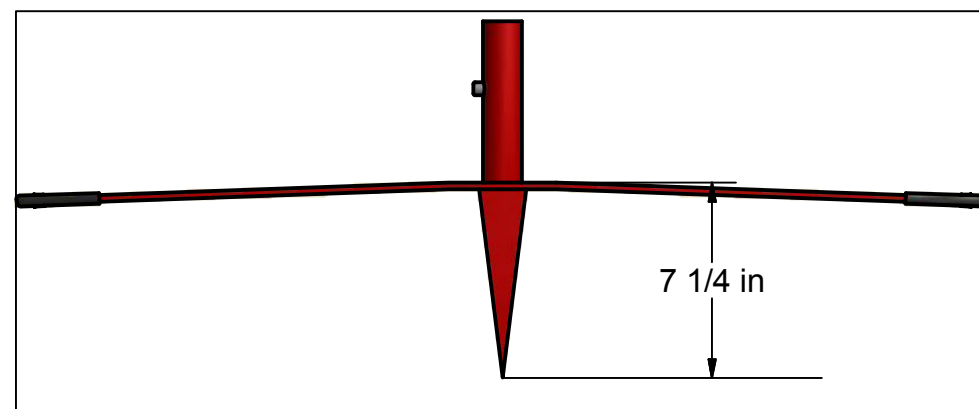

THIRD
ANGLE
PROJECTION



KWIK GOAL

140 Pacific Drive
Quakertown,
Pa. 18951

DIMENSIONS ARE IN INCHES
UNLESS OTHERWISE SPECIFIED

Approved By:

Part #:

Date:

2B1603

This item is the **exclusive**
property of **KWIK GOAL LTD.**
Reproduction or duplication
without the express written
consent of **KWIK GOAL LTD.**
is **strictly forbidden.**

Drawn By: jwillenbecher

Desc:

Date: 8/7/2012

Sheet: 2 of 4

AFR-1 REBOUNDER

Revision #: 5

Cad File: 2B1603.idw

Finish Info.

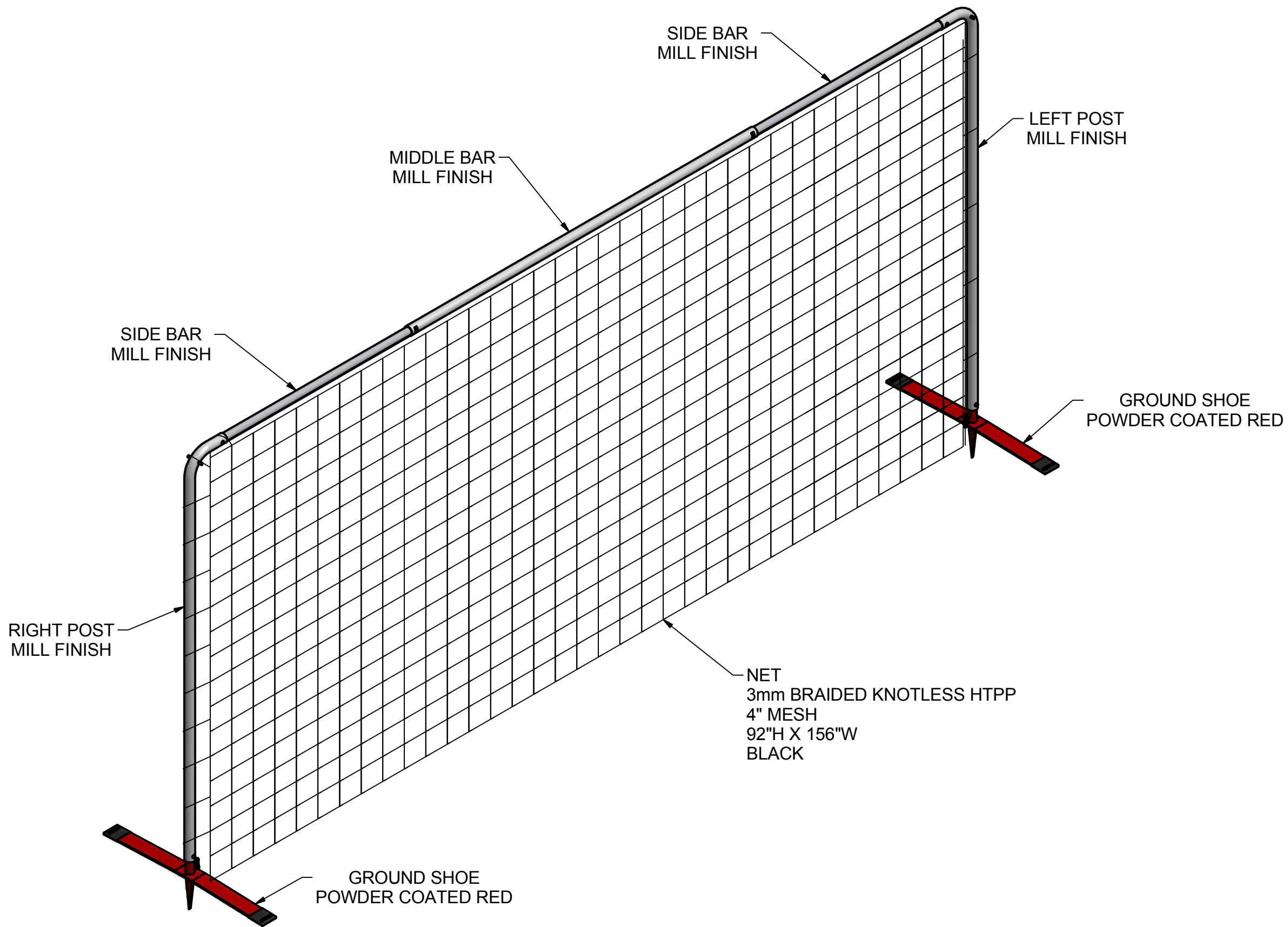

MATERIAL DETAILS

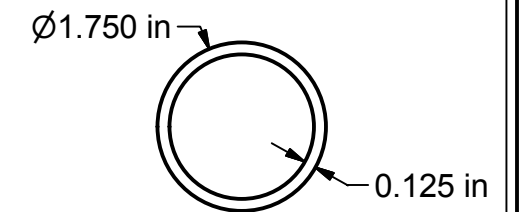

MIDDLE BAR & POSTS
MATERIAL ALUMINUM

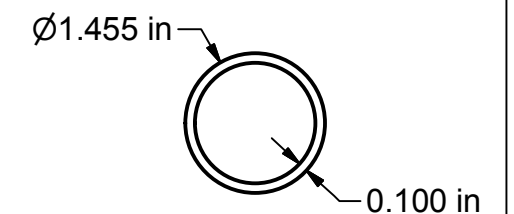

SIDE BAR
MATERIAL ALUMINUM

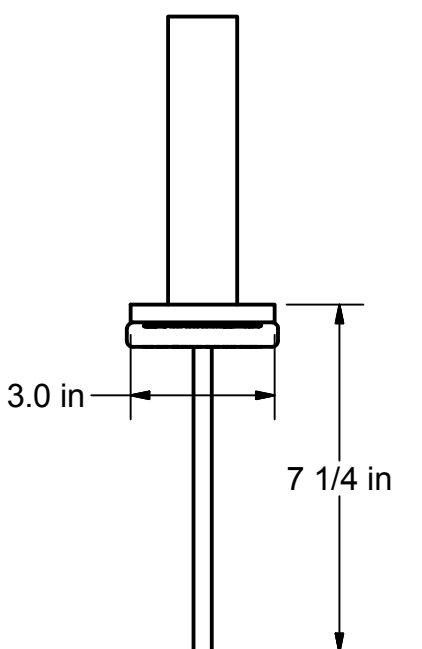
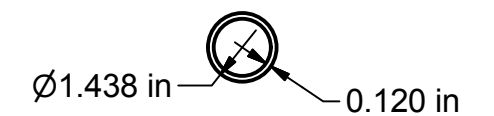

GROUND SHOE
MATERIAL STEEL

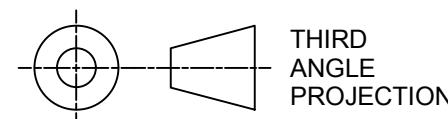

THIRD
ANGLE
PROJECTION

KWIKGOAL® 140 Pacific Drive
Quakertown,
Pa. 18951

DIMENSIONS ARE IN INCHES
UNLESS OTHERWISE SPECIFIED

Approved By:
Date:

Part #:
2B1603

This item is the **exclusive**
property of **KWIK GOAL LTD.**
Reproduction or duplication
without the express written
consent of **KWIK GOAL LTD.**
is **strictly forbidden.**

Drawn By: jwillenbecher
Date: 8/7/2012
Sheet: 3 of 4
Revision #: 5
Cad File: 2B1603.idw

Desc:
AFR-1 REBOUNDER

Finish Info.

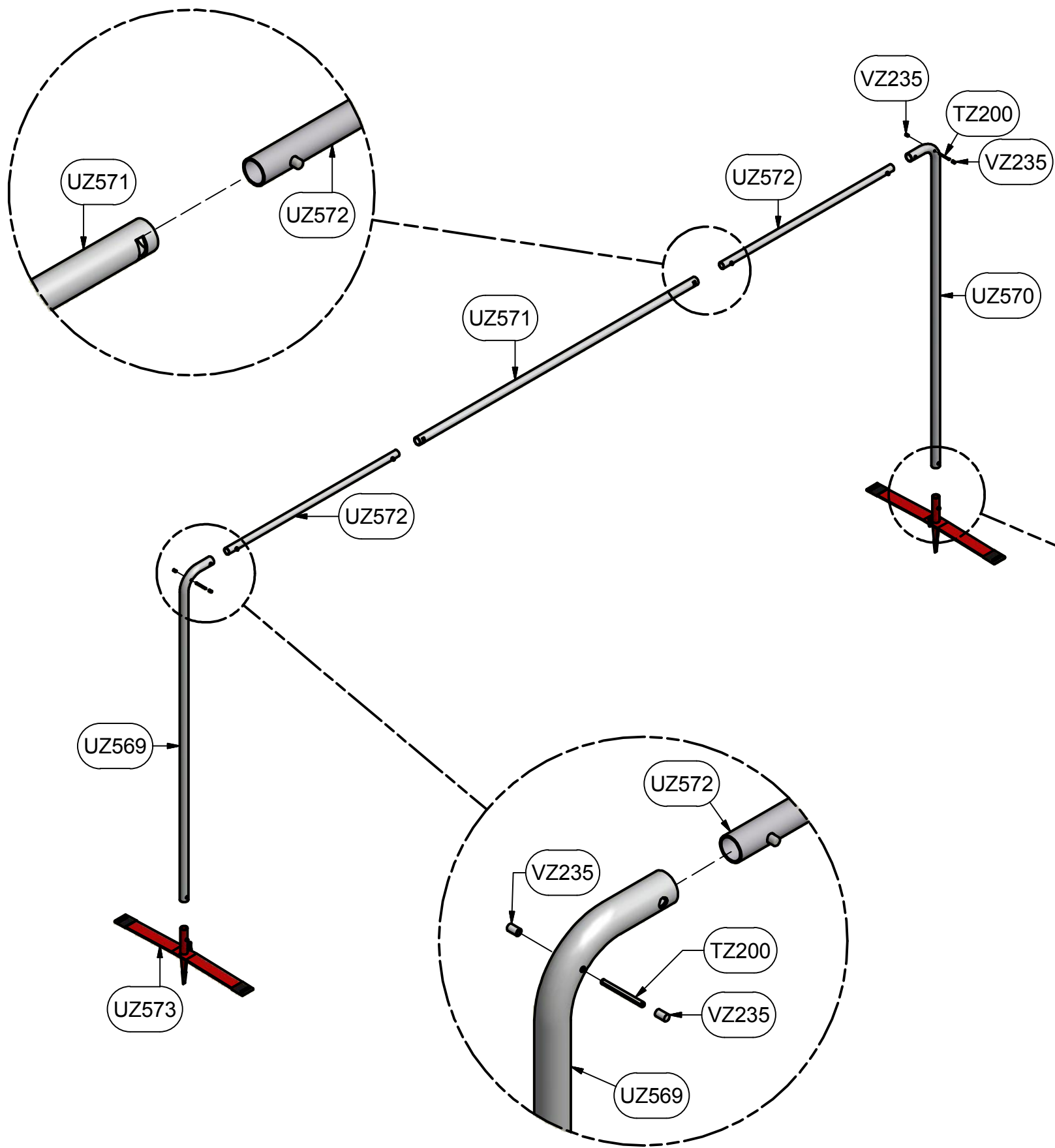

Parts List		
Part#	Qty	Description
UZ569	1	2B1603 RT. POST
UZ570	1	2B1603 LEFT POST
UZ573	2	GROUND SHOE, 2B1603
UZ572	2	2B1603 SIDE BAR
UZ571	1	2B1603 MIDDLE BAR
TZ200	2	ROLL PIN
VZ235	4	CAPLUG
VZ82	2	3/16" Snap Link
VZ602	30	BUNGEE (10B3501 PK OF 30)
UZ847	1	5/8 DIA X 8 L GROUND ANCHOR PEG
3B804	1	NET, REBOUNDER

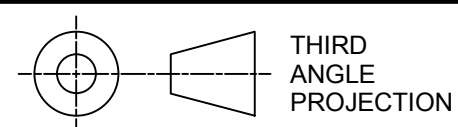

THIRD ANGLE PROJECTION

KWIKGOAL® 140 Pacific Drive
Quakertown, Pa. 18951

DIMENSIONS ARE IN INCHES UNLESS OTHERWISE SPECIFIED

Approved By:
Date:

Part #:
2B1603

This item is the **exclusive** property of **KWIK GOAL LTD.** Reproduction or duplication **without** the express written consent of **KWIK GOAL LTD.** is **strictly forbidden.**

Drawn By: jwillenbecher
Date: 8/7/2012
Sheet: 4 of 4
Revision #: 5
Cad File: 2B1603.idw

Desc:
AFR-1 REBOUNDER

Finish Info.



KWIK GOAL LTD.
2B1603
TOP VIEW

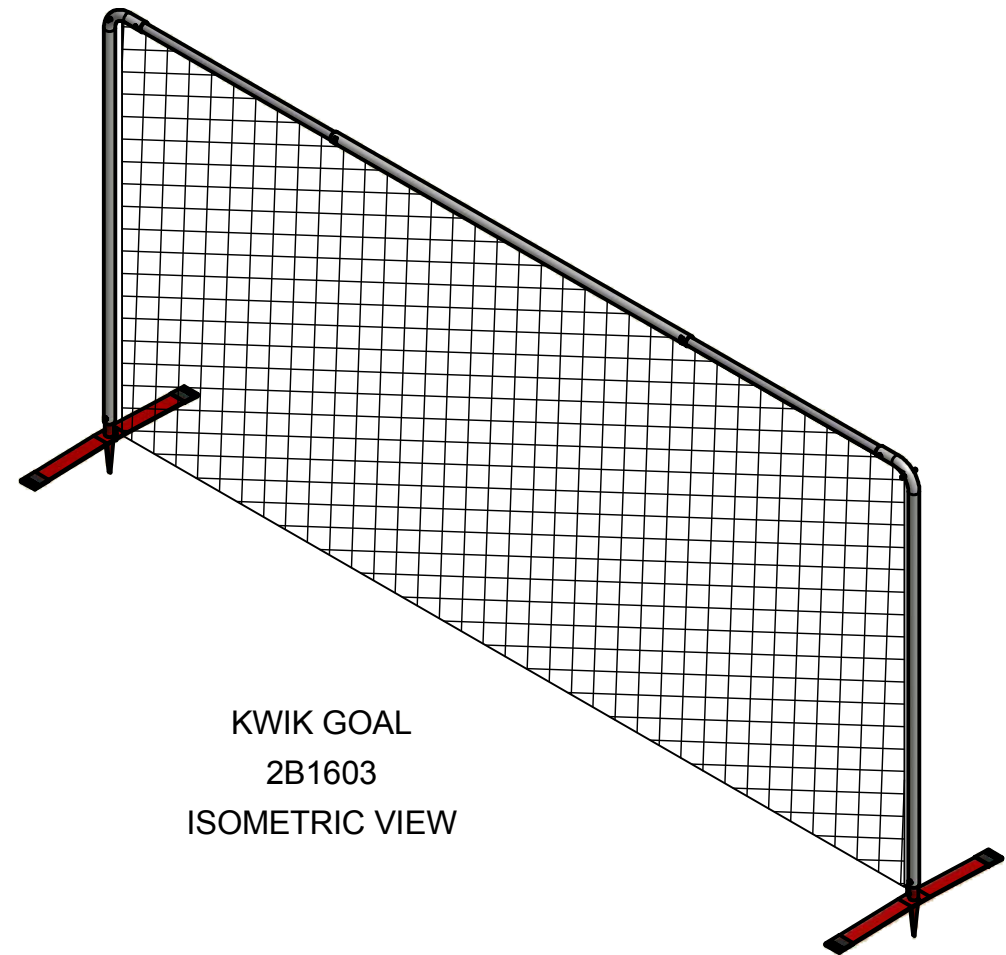

KWIK GOAL
2B1603
ISOMETRIC VIEW

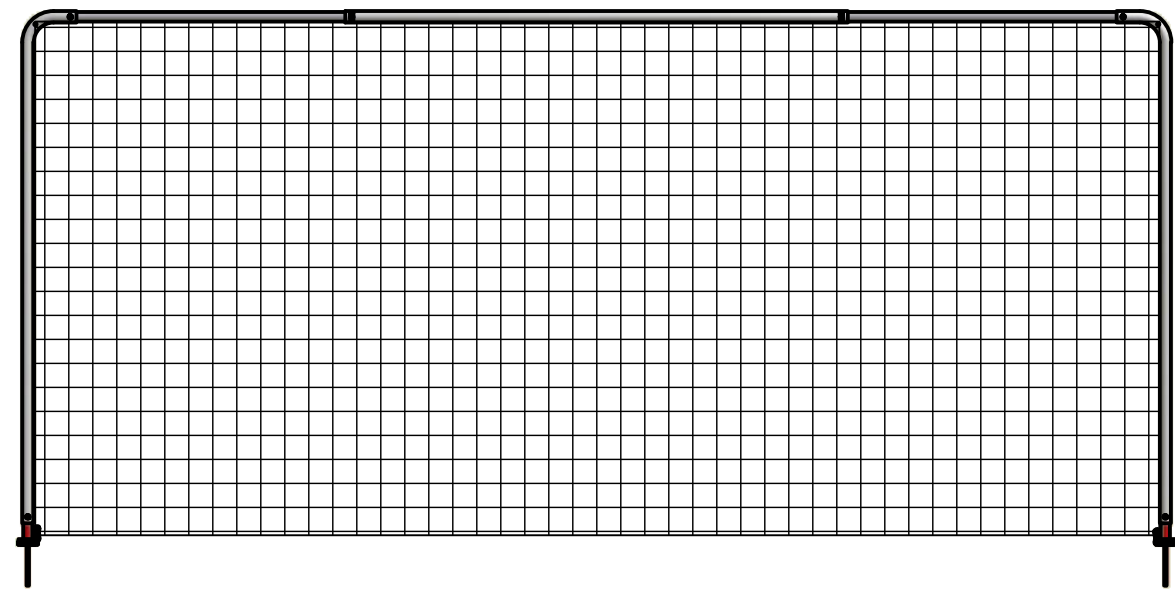

KWIK GOAL LTD.
2B1603
FRONT VIEW

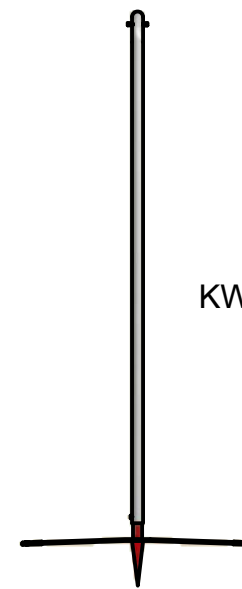

KWIK GOAL LTD.
2B1603
SIDE VIEW

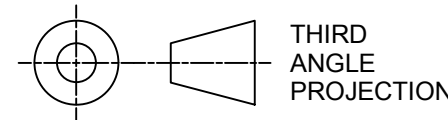

THIRD
ANGLE
PROJECTION

KWIKGOAL[®] 140 Pacific Drive
Quakertown,
Pa. 18951

DIMENSIONS ARE IN INCHES
UNLESS OTHERWISE SPECIFIED

Approved By:
Date:

Part #:
2B1603

This item is the **exclusive**
property of **KWIK GOAL LTD.**
Reproduction or duplication
without the express written
consent of **KWIK GOAL LTD.**
is **strictly forbidden.**

Drawn By: jwillenbecher
Date: 8/7/2012
Sheet: of 4
Revision #: 5
Cad File: 2B1603.idw

Desc:
AFR-1 REBOUNDER

Finish Info.